

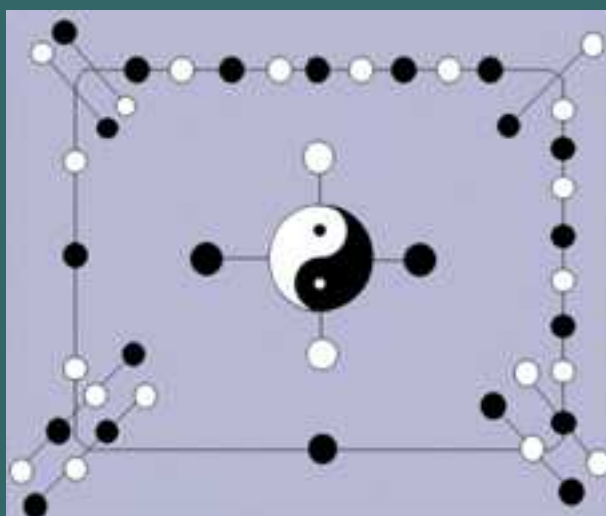

ISSN 1937 - 1055

VOLUME 4, 2014

INTERNATIONAL JOURNAL OF
MATHEMATICAL COMBINATORICS



EDITED BY

THE MADIS OF CHINESE ACADEMY OF SCIENCES AND
BEIJING UNIVERSITY OF CIVIL ENGINEERING AND ARCHITECTURE

December, 2014

Vol.4, 2014

ISSN 1937-1055

International Journal of
Mathematical Combinatorics

Edited By

The Madis of Chinese Academy of Sciences and
Beijing University of Civil Engineering and Architecture

December, 2014

Aims and Scope: The **International J.Mathematical Combinatorics** (*ISSN 1937-1055*) is a fully refereed international journal, sponsored by the *MADIS of Chinese Academy of Sciences* and published in USA quarterly comprising 100-150 pages approx. per volume, which publishes original research papers and survey articles in all aspects of Smarandache multi-spaces, Smarandache geometries, mathematical combinatorics, non-euclidean geometry and topology and their applications to other sciences. Topics in detail to be covered are:

Smarandache multi-spaces with applications to other sciences, such as those of algebraic multi-systems, multi-metric spaces, ···, etc.. Smarandache geometries;

Topological graphs; Algebraic graphs; Random graphs; Combinatorial maps; Graph and map enumeration; Combinatorial designs; Combinatorial enumeration;

Differential Geometry; Geometry on manifolds; Low Dimensional Topology; Differential Topology; Topology of Manifolds; Geometrical aspects of Mathematical Physics and Relations with Manifold Topology;

Applications of Smarandache multi-spaces to theoretical physics; Applications of Combinatorics to mathematics and theoretical physics; Mathematical theory on gravitational fields; Mathematical theory on parallel universes; Other applications of Smarandache multi-space and combinatorics.

Generally, papers on mathematics with its applications not including in above topics are also welcome.

It is also available from the below international databases:

Serials Group/Editorial Department of EBSCO Publishing

10 Estes St. Ipswich, MA 01938-2106, USA

Tel.: (978) 356-6500, Ext. 2262 Fax: (978) 356-9371

<http://www.ebsco.com/home/printsubs/priceproj.asp>

and

Gale Directory of Publications and Broadcast Media, Gale, a part of Cengage Learning

27500 Drake Rd. Farmington Hills, MI 48331-3535, USA

Tel.: (248) 699-4253, ext. 1326; 1-800-347-GALE Fax: (248) 699-8075

<http://www.gale.com>

Indexing and Reviews: Mathematical Reviews (USA), Zentralblatt Math (Germany), Referativnyi Zhurnal (Russia), Matematika (Russia), Directory of Open Access (DoAJ), International Statistical Institute (ISI), International Scientific Indexing (ISI, impact factor 1.235). Institute for Scientific Information (PA, USA), Library of Congress Subject Headings (USA).

Subscription A subscription can be ordered by an email directly to

Linfan Mao

The Editor-in-Chief of *International Journal of Mathematical Combinatorics*

Chinese Academy of Mathematics and System Science

Beijing, 100190, P.R.China

Email: maolinfan@163.com

Price: US\$48.00

Editorial Board (3nd)

Editor-in-Chief

Linfan MAO

Chinese Academy of Mathematics and System
Science, P.R.China
and
Beijing University of Civil Engineering and
Architecture, P.R.China
Email: maolinfan@163.com

Deputy Editor-in-Chief

Guohua Song

Beijing University of Civil Engineering and
Architecture, P.R.China
Email: songguohua@bucea.edu.cn

Editors

S.Bhattacharya

Deakin University
Geelong Campus at Waurn Ponds
Australia
Email: Sukanto.Bhattacharya@Deakin.edu.au

Said Broumi

Hassan II University Mohammedia
Hay El Baraka Ben M'sik Casablanca
B.P.7951 Morocco

Junliang Cai

Beijing Normal University, P.R.China
Email: caijunliang@bnu.edu.cn

Yanxun Chang

Beijing Jiaotong University, P.R.China
Email: yxchang@center.njtu.edu.cn

Jingan Cui

Beijing University of Civil Engineering and
Architecture, P.R.China
Email: cuijingan@bucea.edu.cn

Shaofei Du

Capital Normal University, P.R.China
Email: dushf@mail.cnu.edu.cn

Baizhou He

Beijing University of Civil Engineering and
Architecture, P.R.China
Email: hebaizhou@bucea.edu.cn

Xiaodong Hu

Chinese Academy of Mathematics and System
Science, P.R.China
Email: xdhu@amss.ac.cn

Yuanqiu Huang

Hunan Normal University, P.R.China
Email: hyqq@public.cs.hn.cn

H.Iseri

Mansfield University, USA
Email: hiseri@mnsfld.edu

Xueliang Li

Nankai University, P.R.China
Email: lxl@nankai.edu.cn

Guodong Liu

Huizhou University
Email: lgd@hzu.edu.cn

W.B.Vasantha Kandasamy

Indian Institute of Technology, India
Email: vasantha@iitm.ac.in

Ion Patrascu

Fratii Buzesti National College
Craiova Romania

Han Ren

East China Normal University, P.R.China
Email: hren@math.ecnu.edu.cn

Ovidiu-Ilie Sandru

Politechnica University of Bucharest
Romania

Mingyao Xu

Peking University, P.R.China
Email: xumy@math.pku.edu.cn

Guiying Yan

Chinese Academy of Mathematics and System
Science, P.R.China
Email: yanguiying@yahoo.com

Y. Zhang

Department of Computer Science
Georgia State University, Atlanta, USA

Famous Words:

Nature never deceives us, it is always us who deceive ourselves.

By Jean-Jacques Rousseau, A French philosopher, writer and composer

Spacelike Curves of Constant Breadth According to Bishop Frame in E_1^3

Süha Yılmaz¹, Ümit Ziya Savcı² and Yasin Ünlütürk³

1. Dokuz Eylül University, Buca Educational Faculty, 35150, Buca-Izmir, Turkey

2. Celal Bayar University, Department of Mathematics Education, 45900, Manisa-Turkey

3. Kırklareli University, Department of Mathematics, 39060 Kırklareli, Turkey

E-mail: suha.yilmaz@deu.edu.tr, ziyasavci@hotmail.com, yasinunluturk@klu.edu.tr

Abstract: In this paper, we study a special case of Smarandache breadth curves, and give some characterizations of the space-like curves of constant breadth according to Bishop frame in Minkowski 3-space.

Key Words: Minkowski 3-space, Smarandache breadth curves, curves of constant breadth, Bishop frame.

AMS(2010): 53A05, 53B25, 53B30

§1. Introduction

Curves of constant breadth were introduced by Euler in [3]. Fujivara presented a problem to determine whether there exist space curves of constant breadth or not, and defined the concept of breadth for space curves and also obtained these curves on a surface of constant breadth in [5]. Some geometric properties of curves of constant breadth were given in a plane by [8]. The similar properties were obtained in Euclidean 3-space E^3 in [9]. These kind curves were studied in four dimensional Euclidean space E^4 in [1].

In this paper, we study a special case of Smarandache breadth curves in Minkowski 3-space E_1^3 . A Smarandache curve is a regular curve with 2 breadths or more than 2 breadths in Minkowski 3-space E_1^3 . Also we investigate position vectors of simple closed space-like curves and give some characterizations of curves of constant breadth according to Bishop frame of type-1 in E_1^3 . Thus, we extend this classical topic to the space E_1^3 , which is related to the time-like curves of constant breadth in E_1^3 , see [10] for details. We also use a method which is similar to one in [9].

§2. Preliminaries

The Minkowski 3-space E_1^3 is an Euclidean 3-space E^3 provided with the standard flat metric

¹Received July 3, 2014, Accepted November 26, 2014.

given by

$$\langle , \rangle = -dx_1^2 + dx_2^2 + dx_3^2$$

where (x_1, x_2, x_3) is a rectangular coordinate system of E_1^3 . Since \langle , \rangle is an indefinite metric recall that a vector $v \in E_1^3$ can be one of three Lorentzian characters; it can be space-like if $\langle v, v \rangle > 0$ or $v = 0$, time-like if $\langle v, v \rangle < 0$ and null if $\langle v, v \rangle = 0$ and $v \neq 0$. Similarly, an arbitrary curve $\varphi = \varphi(s)$ in E_1^3 can locally be space-like, time-like or null (light-like) if all of its velocity vector φ' is respectively space-like, time-like or null (light-like) for every $s \in J \in \mathbb{R}$. The pseudo-norm of an arbitrary vector $a \in E_1^3$ is given by $\|a\| = \sqrt{|\langle a, a \rangle|}$. The curve φ is called a unit speed curve if its velocity vector φ' satisfies $\|\varphi'\| = \mp 1$. For any vectors $u, w \in E_1^3$, they are said to be orthogonal if and only if $\langle u, w \rangle = 0$.

Denote by $\{T, N, B\}$ the moving Frenet frame along curve φ in the space E_1^3 . Let φ be a space-like curve with a space-like binormal in the space E_1^3 , as similar to in [11], the Frenet formulae are given as

$$\begin{bmatrix} T' \\ N' \\ B' \end{bmatrix} = \begin{bmatrix} 0 & \kappa & 0 \\ \kappa & 0 & \tau \\ 0 & \tau & 0 \end{bmatrix} \begin{bmatrix} T \\ N \\ B \end{bmatrix} \quad (2.1)$$

where κ and τ are the first and second curvatures with

$$\begin{aligned} \langle T, T \rangle &= \langle B, B \rangle = 1, \quad \langle N, N \rangle = -1, \\ \langle T, N \rangle &= \langle T, B \rangle = \langle N, B \rangle = 0. \end{aligned}$$

The construction of the Bishop frame is due to L.R.Bishop in [4]. This frame or parallel transport frame is an alternative approach to defining a moving frame that is well defined even the space-like curve with a space-like binormal has vanishing second derivative [2]. He used tangent vector and any convenient arbitrary basis for the remainder of the frame. Then, as similar to in [2], the Bishop frame is expressed as

$$\begin{bmatrix} T' \\ N_1' \\ N_2' \end{bmatrix} = \begin{bmatrix} 0 & k_1 & -k_2 \\ k_1 & 0 & 0 \\ k_2 & 0 & 0 \end{bmatrix} \begin{bmatrix} T \\ N_1 \\ N_2 \end{bmatrix} \quad (2.2)$$

and

$$\kappa(s) = \sqrt{|k_1^2 - k_2^2|}, \quad \tau(s) = \frac{d\theta}{ds}, \quad \theta(s) = \tanh^{-1} \frac{k_2}{k_1} \quad (2.3)$$

where k_1 and k_2 are Bishop curvatures.

§3. Spacelike Curves of Constant Breadth According to Bishop Frame in E_1^3

Let $\vec{\varphi} = \vec{\varphi}(s)$ and $\vec{\varphi}^* = \vec{\varphi}^*(s)$ be simple closed curves of constant breadth in Minkowski 3-space. These curves will be denoted by C and C^* . The normal plane at every point P on the curve meets the curve in the class Γ having parallel tangents \vec{T} and \vec{T}^* in opposite directions

at the opposite points φ and φ^* of the curve as in [5]. A simple closed curve of constant breadth having parallel tangents in opposite directions at opposite points can be represented with respect to Bishop frame by the equation

$$\varphi^*(s) = \varphi(s) + m_1 T + m_2 N_1 + m_3 N_2 \quad (3.1)$$

where $m_i(s)$, $1 \leq i \leq 3$ are arbitrary functions, also φ and φ^* are opposite points. Differentiating (3.1) and considering Bishop equations, we have

$$\begin{aligned} \frac{d\varphi^*}{ds} = \vec{T}^* \frac{ds^*}{ds} = & \left(\frac{dm_1}{ds} + m_2 k_1 + m_3 k_2 + 1 \right) T \\ & + \left(\frac{dm_2}{ds} + m_1 k_1 \right) N_1 + \left(\frac{dm_3}{ds} - m_1 k_2 \right) N_2. \end{aligned} \quad (3.2)$$

Since $T^* = -T$, rewriting (3.2), we obtain the following equations

$$\begin{cases} \frac{dm_1}{ds} = -m_2 k_1 - m_3 k_2 - 1 - \frac{ds^*}{ds} \\ \frac{dm_2}{ds} = -m_1 k_1 \\ \frac{dm_3}{ds} = m_1 k_2. \end{cases} \quad (3.3)$$

If we call θ as the angle between the tangent of the curve (C) at point $\varphi(s)$ with a given direction and consider $\frac{d\theta}{ds} = \tau$, we can rewrite (3.3) as follow;

$$\begin{cases} \frac{dm_1}{d\theta} = -m_2 \frac{k_1}{\tau} - m_3 \frac{k_2}{\tau} - f(\theta) \\ \frac{dm_2}{d\theta} = -m_1 \frac{k_1}{\tau} \\ \frac{dm_3}{d\theta} = m_1 \frac{k_2}{\tau} \end{cases} \quad (3.4)$$

where

$$f(\theta) = \delta + \delta^* \quad \delta = \frac{1}{\tau}, \delta^* = \frac{1}{\tau^*} \quad (3.5)$$

denote the radius of curvature at the points φ and φ^* , respectively. And using the system (3.4), we have the following differential equation with respect to m_1 as

$$\begin{aligned} \frac{d^3 m_1}{d\theta^3} - \left(\frac{\kappa}{\tau} \right)^2 \frac{dm_1}{d\theta} + \left[\frac{k_2}{\tau} \frac{d}{d\theta} \left(\frac{k_2}{\tau} \right) - \frac{d}{d\theta} \left(\frac{\kappa}{\tau} \right)^2 - \frac{\kappa}{\tau} \frac{d}{d\theta} \left(\frac{k_2}{\tau} \right) \right] m_1 \\ + \left(\int_0^\theta m_1 \frac{k_2}{\tau} d\theta \right) \frac{d^2}{d\theta^2} \left(\frac{k_2}{\tau} \right) - \left(\int_0^\theta m_1 \frac{k_1}{\tau} d\theta \right) \frac{d^2}{d\theta^2} \left(\frac{k_1}{\tau} \right) + \frac{d^2 f}{d\theta^2} = 0. \end{aligned} \quad (3.6)$$

The equation (3.6) is characterization of the point φ^* . If the distance between opposite

points of (C) and (C^*) is constant, then we write that

$$\|\varphi^* - \varphi\| = -m_1^2 + m_2^2 + m_3^2 = l^2 \text{ is constant.} \quad (3.7)$$

Hence, from (3.7) we obtain

$$-m_1 \frac{dm_1}{d\theta} + m_2 \frac{dm_2}{d\theta} + m_3 \frac{dm_3}{d\theta} = 0 \quad (3.8)$$

Considering system (3.4), we get

$$m_1 \left[2m_3 \frac{k_2}{\tau} + f(\theta) \right] = 0 \quad (3.9)$$

From (3.9), we study the following cases which are depended on the conditions $2m_3 \frac{k_2}{\tau} + f(\theta) = 0$ or $m_1 = 0$.

Case 1. If $2m_3 \frac{k_2}{\tau} + f(\theta) = 0$ then by using (3.4), we obtain

$$\frac{dm_1}{d\theta} - \left(\int_0^\theta m_1 \frac{k_1}{\tau} d\theta \right) \frac{k_1}{\tau} + \frac{f(\theta)}{\tau} = 0. \quad (3.10)$$

Now let us to investigate solution of the equation (3.6) and suppose that m_2, m_3 and $f(\theta)$ are constants, $m_1 \neq 0$, then using (3.4) in (3.6), we have the following differential equation

$$\frac{d^3 m_1}{d\theta^3} - \left(\frac{\kappa}{\tau} \right)^2 \frac{dm_1}{d\theta} - \frac{d}{d\theta} \left(\frac{\kappa}{\tau} \right)^2 m_1 = 0. \quad (3.11)$$

The general solution of (3.11) depends on the character of the ratio $\frac{\kappa}{\tau}$. Suppose that φ is not constant breadth. For this reason, we distinguish the following sub-cases.

Subcase 1.1 Suppose that φ is an inclined curves then the solution of the differential equation (3.11) is

$$m_1 = c_1 + c_2 e^{-\frac{\kappa}{\tau}\theta} + c_3 e^{\frac{\kappa}{\tau}\theta}. \quad (3.12)$$

Therefore, we have m_2 and m_3 , respectively,

$$\begin{aligned} m_2 &= -\int_0^\theta (c_1 + c_2 e^{-\frac{\kappa}{\tau}\theta} + c_3 e^{\frac{\kappa}{\tau}\theta}) \frac{k_1}{\tau} d\theta \\ m_3 &= \int_0^\theta (c_1 + c_2 e^{-\frac{\kappa}{\tau}\theta} + c_3 e^{\frac{\kappa}{\tau}\theta}) \frac{k_2}{\tau} d\theta \end{aligned} \quad (3.13)$$

where c_1, c_2 and c_3 are real numbers.

Subcase 1.2 Suppose that φ is a line. The solution is in the following form

$$m_1 = A_1 \frac{\theta^2}{2} + A_2 \theta + A_3. \quad (3.14)$$

Hence, we have m_2 and m_3 as follows

$$\begin{aligned} m_2 &= -\int_0^\theta (A_1 \frac{\theta^2}{2} + A_2 \theta + A_3) \frac{k_1}{\tau} d\theta \\ m_3 &= \int_0^\theta (A_1 \frac{\theta^2}{2} + A_2 \theta + A_3) \frac{k_2}{\tau} d\theta \end{aligned} \quad (3.15)$$

where A_1 , A_2 and A_3 are real numbers.

Case 2. If $m_1 = 0$, then $m_2 = M_2$ and $m_3 = M_3$ are constants. Let us suppose that $m_2 = m_3 = c$ (constant). Thus, the equation (3.4) is obtained as

$$f(\theta) = \frac{-c(k_1 + k_2)}{\tau}.$$

This means that the curve is a circle. Moreover, the equation (3.6) has the form

$$\frac{d^2 f}{d\theta^2} = 0. \quad (3.16)$$

The solution of (3.16) is

$$f(\theta) = l_1 \theta + l_2 \quad (3.17)$$

where l_1 and l_2 are real numbers. Therefore, we write the position vector φ^* as follows

$$\varphi^* = \varphi + M_2 N_1 + M_3 N_2 \quad (3.18)$$

where M_2 and M_3 are real numbers.

Finally, the distance between the opposite points of the curves (C) and (C^*) is

$$\|\varphi^* - \varphi\| = M_2^2 + M_3^2 = \text{constant}. \quad (3.19)$$

References

- [1] A.Mağden and Ö. Köse, On the curves of constant breadth, *Tr. J. of Mathematics*, pp. 227-284, 1997.
- [2] B.Bükçü and M.Karacan, The Bishop Darboux rotation axis of the space-like curves in Minkowski 3-space, *E.U.F.F, JFS*, Vol 3, pp 1-5, 2007.
- [3] L.Euler, *De Curvis Trangularibus*, Acta Acad. Petropol, pp:3-30, 1870.
- [4] L.R.Bishop, There is more than one way to frame a curve, *Amer. Math. Monthly*, Vol 82, pp:246-251, 1975.
- [5] M.Fujivara, On space curves of constant breadth, *Tohoku Math. J.*, Vol:5, pp. 179-184,

- 1914.
- [6] M.Petroviç-Torgasev and E.Nesoviç, Some characterizations of the space-like, the time-like and the null curves on the pseudo-hyperbolic space H_0^2 in E_1^3 , *Kragujevac J. Math.*, Vol 22, pp:71-82, 2000.
 - [7] N.Ekmekçi, *The Inclined Curves on Lorentzian Manifolds*,(in Turkish) PhD dissertation, Ankara Universty, 1991.
 - [8] Ö. Köse, Some properties of ovals and curves of constant width in a plane, *Doğa Turk Math. J.*, Vol.8, pp:119-126, 1984.
 - [9] Ö. Köse, On space curves of constant breadth, *Doğa Turk Math. J.*, Vol:(10) 1, pp. 11-14, 1986.
 - [10] S.Yılmaz and M. Turgut, On the time-like curves of constant breadth in Minkowski 3-space, *International J. Math. Combin.*, Vol 3, pp:34-39, 2008.
 - [11] A.Yücesan, A.C.Çöken, N. Ayyıldız, On the Darboux rotation axis of Lorentz space curve, *Appl. Math. Comp.*, Vol 155, pp:345-351, 2004.

Study Map of Orthotomic of a Circle

Ö. Gökmen Yildiz and H.Hilmi Hacisalihoğlu

(Department of Mathematics, Faculty of Sciences and Arts, University of Bilecik Şeyh Edebali, Turkey)

E-mail: ogokmen.yildiz@bilecik.edu.tr, h.hacisali@bilecik.edu.tr

Abstract: In this paper, we calculate and discuss the Study map of an spherical orthotomic of a circle which lies on the dual unit sphere in D -module. In order to do this we use matrix equation of Study mapping. Finally we give some special cases each of which is a geometric result.

Key Words: Study mapping, D -module, orthotomic, spherical orthotomic.

AMS(2010): 53A04, 53A25

§1. Introduction

In linear algebra, dual numbers are defined by W. K. Clifford (1873) by using real numbers. Dual numbers are extended the real numbers by adjoining one new element ε with the property $\varepsilon^2 = 0$. Dual numbers have the form $x + \varepsilon y$, where $x, y \in R$. The dual numbers set is two-dimensional commutative unital associative algebra over the real numbers. Its first application was made by E. Study. He used dual numbers and dual vectors in his research on the geometry of lines and kinematics [15]. He devoted special attention to the representation of directed line by dual unit vectors and defined the mapping which is called with his name. There exists one to one correspondence between dual unit points of dual unit sphere and the directed lines of the Euclidean line space E^3 .

Let α be a regular curve and \vec{T} be its tangent, and u be a source. Orthotomic of α with respect to the source (u) is the locus of reflection of u about the tangents \vec{T} [7]. Bruce and Giblin studied the unfolding theory to the evolutes and orthotomics of plane and space curves [3], [4] and [5]. Georgiou, Hasanis and Koutroufiotis investigated the orthotomics in Euclidean $(n + 1)$ -space E^{n+1} [6]. Alamo and Criado studied the antiorthotomics in Euclidean $(n+1)$ -space E^{n+1} [1]. Xiong defined the spherical orthotomic and the spherical antiorthotomic [16]. In this paper we examine the Study Map of the spherical orthotomic of a circle which lies on the dual unit sphere in D -Module.

§2. Preliminaries

If a and a^* are real numbers and $\varepsilon^2 = 0$ but $\varepsilon \notin R$, a dual number can be written as $A = a + \varepsilon a^*$,

¹Received May 16, 2014, Accepted November 28, 2014.

where $\varepsilon = (0, 1)$ is the dual unit.

The set $D = \{A = a + \varepsilon a^* \mid a, a^* \in R\}$ of dual numbers is a commutative ring over the real number field and is denoted by D . Then the set

$$D^3 = \left\{ \vec{A} = (A_1, A_2, A_3) \mid A_i \in D, 1 \leq i \leq 3 \right\}$$

is a module over the ring D which is called a D -Module, under the addition and the scalar multiplication on the set D ([12]). The elements of D^3 are called dual vectors. Thus a dual vector has the form $\vec{A} = \vec{a} + \varepsilon \vec{a}^*$, where \vec{a} and \vec{a}^* are real vectors at R^3 . Then, for any vectors \vec{A} and \vec{B} in D^3 , the inner product and the vector product of these vectors are defined as

$$\langle \vec{A}, \vec{B} \rangle = \langle \vec{a}, \vec{b} \rangle + \varepsilon (\langle \vec{a}, \vec{b}^* \rangle + \langle \vec{a}^*, \vec{b} \rangle)$$

and

$$\vec{A} \wedge \vec{B} = \vec{a} \wedge \vec{b} + \varepsilon (\vec{a} \wedge \vec{b}^* + \vec{a}^* \wedge \vec{b}),$$

respectively. The norm $\|\vec{A}\|$ of $\vec{A} = \vec{a} + \varepsilon \vec{a}^*$ is defined as

$$\|\vec{A}\| = \|\vec{a}\| + \varepsilon \frac{\langle \vec{a}, \vec{a}^* \rangle}{\|\vec{a}\|}, \quad \vec{a} \neq 0.$$

The dual vector \vec{A} with norm 1 is called a dual unit vector. The set of dual unit vectors

$$S^2 = \left\{ \vec{A} = \vec{a} + \varepsilon \vec{a}^* \in D^3 \mid \|\vec{A}\| = 1; \in D, \vec{a}, \vec{a}^* \in R^3 \right\}$$

is called the dual unit sphere.

Now, we give the definition of spherical normal, spherical tangent and spherical orthotomic of a spherical curve α . $\{\vec{T}, \vec{N}, \vec{B}\}$ be the Frenet frame of α . The spherical normal of α is the great circle which passing through $\alpha(s)$ and normal to α at $\alpha(s)$ and is given by

$$\begin{cases} \langle \vec{x}, \vec{x} \rangle = 1 \\ \langle \vec{x}, \vec{T} \rangle = 0 \end{cases}$$

where x is an arbitrary point of spherical normal. The spherical tangent of α is the great circle which tangent to α at $\alpha(s)$ and is given by

$$\begin{cases} \langle \vec{y}, \vec{y} \rangle = 1 \\ \langle \vec{y}, (\vec{\alpha} \wedge \vec{T}) \rangle = 0 \end{cases}$$

where y is an arbitrary point of spherical tangent.

Let $u \in S^2$ be a source. Xiong defined the spherical orthotomic of α relative to u to be ([17]) the set of reflections of u about the planes whose lie on the above great circles for all $s \in I$ and given by

$$\vec{u} = 2 \langle (\vec{\alpha} - \vec{u}), \vec{v} \rangle \vec{v} + \vec{u}$$

$$\text{where } \vec{v} = \frac{\vec{B} - \langle \vec{B}, \vec{\alpha} \rangle \vec{\alpha}}{\|\vec{B} - \langle \vec{B}, \vec{\alpha} \rangle \vec{\alpha}\|}.$$

§3. Study Mapping

Definition 3.1 *The Study mapping is an one to one mapping between the dual points of a dual unit sphere, in D -Module, and the oriented lines in the Euclidean line space E^3 .*

Let K, O and $\{\vec{O}; \vec{E}_1, \vec{E}_2, \vec{E}_3\}$ denote the unit dual sphere, the center of K and dual orthonormal system at O , respectively where

$$\vec{E}_i = \vec{e}_i + \varepsilon \vec{e}_i^*; 1 \leq i \leq 3. \quad (3.1)$$

Let S_3 be the group of all the permutations of the set $\{1, 2, 3\}$, then it can be written as

$$\left\{ \begin{array}{l} \vec{E}_{\sigma(1)} = \text{sgn}(\sigma) \vec{E}_{\sigma(2)} \wedge \vec{E}_{\sigma(3)}, \text{sgn}(\sigma) = \pm 1, \\ \sigma = \begin{pmatrix} 1 & 2 & 3 \\ \sigma(1) & \sigma(2) & \sigma(3) \end{pmatrix} \end{array} \right. \quad (3.2)$$

In the case that the orthonormal system

$$\{\vec{O}; \vec{e}_1, \vec{e}_2, \vec{e}_3\}$$

is the system of the line space E^3 . We can write the moment vectors \vec{e}_i^* as

$$\vec{e}_i^* = \overline{MO} \wedge \vec{e}_i, 1 \leq i \leq 3. \quad (3.3)$$

Since these moment vectors are the vectors of R^3 , we may write that

$$\vec{e}_i^* = \sum_{j=1}^3 \lambda_{ij} \vec{e}_j, \lambda_{ij} \in R, 1 \leq i \leq 3. \quad (3.4)$$

Hence (3.3) and (3.4) give us

$$\lambda_{ii} = 0, \lambda_{ij} = -\lambda_{ji}, 1 \leq i, j \leq 3$$

and so the scalars λ_{ij} are denoted by λ_i , that is,

$$\lambda_{ij} = \lambda_i.$$

Then (3.4) reduces to

$$\begin{bmatrix} \vec{e}_1^* \\ \vec{e}_2^* \\ \vec{e}_3^* \end{bmatrix} = \begin{bmatrix} 0 & \lambda_1 & -\lambda_3 \\ -\lambda_1 & 0 & \lambda_2 \\ \lambda_3 & -\lambda_2 & 0 \end{bmatrix} \begin{bmatrix} \vec{e}_1 \\ \vec{e}_2 \\ \vec{e}_3 \end{bmatrix}. \quad (3.5)$$

Hence the Study mapping

$$K \rightarrow E^3$$

can be given as a mapping from the dual orthonormal system to the real orthonormal system. By using the relations (3.1) and (3.5), we can express Study mapping in the matrix form as follows:

$$\begin{bmatrix} \vec{E}_1 \\ \vec{E}_2 \\ \vec{E}_3 \end{bmatrix} = \begin{bmatrix} 1 & \lambda_1\varepsilon & -\lambda_3\varepsilon \\ -\lambda_1\varepsilon & 1 & \lambda_2\varepsilon \\ \lambda_3\varepsilon & -\lambda_2\varepsilon & 1 \end{bmatrix} \begin{bmatrix} \vec{e}_1 \\ \vec{e}_2 \\ \vec{e}_3 \end{bmatrix} \quad (3.6)$$

which says that Study mapping corresponds with a dual orthogonal matrix. Since we know [14] that the linear mappings are in one to one correspondence with the matrices we may give the following theorem.

Theorem 3.2 *A Study mapping is a linear isomorphism.*

Since the Euclidean motions in E^3 leave do not change the angle and the distance between two lines, the corresponding mapping in D -Module leave the inner product invariant.

This is the action of an orthogonal matrix with dual coefficients. Since the center of the dual unit sphere K must remain fixed the transformation group in D -module (the image of the Euclidean motions) does not contain any translations. Hence, in order to represents the Euclidean motions in D -Module we can apply the following theorem [8].

Theorem 3.3 *The Euclidean motions in E^3 are in one to one correspondence with the dual orthogonal matrices.*

Definition 3.4 *A ruled surface is a surface that can be swept out by moving a line in space. This line is the generator of surface.*

A differentiable curve

$$t \in R \rightarrow \vec{X}(t) \in K$$

on the dual unit sphere K , depending on a real parameter t , represents differentiable family of straight lines of which is ruled surface ([2], [8]). The lines $\vec{X}(t)$ are the generators of the surface.

Let X, Y be two different points of K and Φ be the dual angle (\vec{OX}, \vec{OY}) . The dual angle Φ has a value $\varphi + \varepsilon\varphi^*$ which is a dual number, where φ and φ^* are the angle and the minimal distance between the two lines \vec{X} and \vec{Y} , respectively. Then we have the following theorem ([8]).

Theorem 3.5 Let $\vec{X}, \vec{Y} \in K$. Then we have

$$\langle \vec{X}, \vec{Y} \rangle = \cos \Phi,$$

where

$$\cos \Phi = \cos \varphi - \varepsilon \varphi^* \sin \varphi. \quad (3.7)$$

The following special cases of Theorem 3.5 are important ([9]):

$$\langle \vec{X}, \vec{Y} \rangle = 0 \implies \varphi = \frac{\pi}{2} \text{ and } \varphi^* = 0; \quad (3.8)$$

meaning that the lines \vec{X} and \vec{Y} meet at a right angle.

$$\langle \vec{X}, \vec{Y} \rangle = \text{pure dual} \implies \varphi = \frac{\pi}{2} \text{ and } \varphi^* \neq 0; \quad (3.9)$$

meaning that the lines \vec{X} and \vec{Y} are orthogonal skew lines.

$$\langle \vec{X}, \vec{Y} \rangle = \text{pure real} \implies \varphi \neq \frac{\pi}{2} \text{ and } \varphi^* = 0; \quad (3.10)$$

this means that the lines \vec{X} and \vec{Y} intersect each other.

$$\langle \vec{X}, \vec{Y} \rangle = \pm 1 \implies \varphi^* = 0 \text{ and } \varphi = 0 \text{ (or } \varphi = \pi); \quad (3.11)$$

meaning that the lines \vec{X} and \vec{Y} are coincide (their senses are either same or opposite).

§4. The Study Map of a Circle

Let g be the straight line corresponding to the unit dual vector \vec{E}_3 . If we choose the point M on g then we have

$$\lambda_2 = \lambda_3 = 0$$

and so the matrix, from (3.6) reduces to

$$\begin{bmatrix} \vec{E}_1 \\ \vec{E}_2 \\ \vec{E}_3 \end{bmatrix} = \begin{bmatrix} 1 & \lambda_1 \varepsilon & 0 \\ -\lambda_1 \varepsilon & 1 & 0 \\ 0 & 0 & 1 \end{bmatrix} \begin{bmatrix} \vec{e}_1 \\ \vec{e}_2 \\ \vec{e}_3 \end{bmatrix} \quad (4.1)$$

The inverse of this mapping is

$$\begin{bmatrix} \vec{e}_1 \\ \vec{e}_2 \\ \vec{e}_3 \end{bmatrix} = \begin{bmatrix} 1 & -\lambda_1 \varepsilon & 0 \\ \lambda_1 \varepsilon & 1 & 0 \\ 0 & 0 & 1 \end{bmatrix} \begin{bmatrix} \vec{E}_1 \\ \vec{E}_2 \\ \vec{E}_3 \end{bmatrix} \quad (4.2)$$

Let

$$S = \{\vec{X} \mid \langle \vec{X}, \vec{E}_3 \rangle = \cos \Phi = \text{constant}, \vec{X} \in K\}$$

be the circle on the unit dual sphere K . The spherical orthotomic of the great circle which lies on the plane spanned by $\{\vec{E}_1, \vec{E}_2\}$ relative to S is a reflection of S about this plane and for $\vec{X} = (X_1, X_2, X_3) \in S$, it is given by $\vec{\tilde{X}} = (X_1, X_2, -X_3)$. Thus the dual vector $\vec{\tilde{X}}$ can be expressed as

$$\vec{\tilde{X}} = \sin \Phi \cos \Psi \vec{E}_1 + \sin \Phi \sin \Psi \vec{E}_2 - \cos \Phi \vec{E}_3 \quad (4.3)$$

where $\Phi = \varphi + \varepsilon\varphi^*$ and $\Psi = \psi + \varepsilon\psi^*$ are the dual angles. Since we have the relations

$$\begin{cases} \vec{\tilde{X}} = \vec{\tilde{x}} + \varepsilon \vec{\tilde{x}}^* \\ \sin \Phi = \sin \varphi + \varepsilon\varphi^* \cos \varphi, \quad \sin \Psi = \sin \psi + \varepsilon\psi^* \cos \psi \\ \cos \Phi = \cos \varphi - \varepsilon\varphi^* \sin \varphi, \quad \cos \Psi = \cos \psi - \varepsilon\psi^* \sin \psi \end{cases}$$

These equations (4.1) and (4.3) give us the vectors $\vec{\tilde{x}}$ and $\vec{\tilde{x}}^*$ in the matrix form:

$$\begin{cases} \vec{\tilde{x}} = \begin{bmatrix} \vec{e}_1 & \vec{e}_2 & \vec{e}_3 \end{bmatrix} \begin{bmatrix} \sin \varphi \cos \psi \\ \sin \varphi \sin \psi \\ -\cos \varphi \end{bmatrix} \\ \vec{\tilde{x}}^* = \begin{bmatrix} \vec{e}_1 & \vec{e}_2 & \vec{e}_3 \end{bmatrix} \begin{bmatrix} \varphi^* \cos \varphi \cos \psi - (\psi^* + \lambda_1) \sin \varphi \sin \psi \\ \varphi^* \cos \varphi \sin \psi + (\psi^* + \lambda_1) \sin \varphi \cos \psi \\ \varphi^* \sin \varphi \end{bmatrix} \end{cases} \quad (4.4)$$

On the other hand, the point $\vec{\tilde{X}}$ is on the circle with center on the axis \vec{E}_3 . As $\vec{\tilde{X}}$ is spherical orthotomic of \vec{X} , \vec{X} is on the circle which is reflected about the plane spanned by $\{\vec{E}_1, \vec{E}_2\}$. Thus we may write

$$\langle \vec{\tilde{X}}, \vec{E}_3 \rangle = \cos \Phi = \cos \varphi - \varepsilon\varphi^* \sin \varphi = \text{constant} \quad (4.5)$$

which means that $\varphi = c_1(\text{constant})$ and $\varphi^* = c_2(\text{constant})$.

The equation (4.4) and (4.5) let us to write the following relations:

$$\begin{cases} \langle \vec{\tilde{x}}, \vec{\tilde{x}} \rangle = 1 \\ \langle \vec{\tilde{x}}, \vec{\tilde{x}}^* \rangle = 0 \\ \langle \vec{\tilde{x}}, \vec{e}_3 \rangle - \cos \varphi = 0 \\ \langle \vec{\tilde{x}}, \vec{e}_3 \rangle + \langle \vec{\tilde{x}}^*, \vec{e}_3 \rangle + \varphi^* \sin \varphi = 0 \end{cases} \quad (4.6)$$

The equations (4.6) have only two parameter ψ and ψ^* so (4.6) represents a line congruence in R^3 . This congruence is called spherical orthotomic congruence.

Now we may calculate the equations of this spherical orthotomic congruence in Plucker coordinates. Let \vec{y} be a point of the spherical orthotomic congruence then we have ([12]).

$$\vec{y} = \vec{x}(\psi, \psi^*) \wedge \vec{x}^*(\psi, \psi^*) + v \vec{x}(\psi, \psi^*). \quad (4.7)$$

If the coordinates of \vec{y} are (y_1, y_2, y_3) then (4.7) give us

$$\begin{cases} y_1 = \varphi^* \sin \psi + (\psi^* + \lambda_1) \sin \varphi \cos \varphi \cos \psi + v \sin \varphi \cos \psi \\ y_2 = -\varphi^* \cos \psi + (\psi^* + \lambda_1) \sin \varphi \cos \varphi \sin \psi + v \sin \varphi \sin \psi \\ y_3 = (\psi^* + \lambda_1) \sin^2 \varphi - v \cos \varphi \end{cases} \quad (4.8)$$

In this case that $\varphi \neq \frac{\pi}{2}$ (4.8) give us

$$\frac{y_1^2}{c_2^2} + \frac{y_2^2}{c_2^2} - \frac{[y_3 - (\psi^* + \lambda_1)]^2}{[c_2 \cot c_1]^2} = 1 \quad (4.9)$$

which has two parameters ψ^* and λ_1 so it represents a line congruence with degree two. The lines of this congruence are located so that

- a) The shortest distance of these lines and the line g is $\varphi^* = c_2$;
- b) The angle of these lines and the line g is $\varphi = c_1$.

Thus, it can be seen that the lines of spherical orthotomic congruence intersect the generators of a cylinder whose radius is $\varphi^* = \text{constant}$, and the axis is g , under the angle $\varphi = \text{constant}$.

Definition 4.1 *If all the lines of a line congruence have a constant angle with a definite line then the congruence is called an inclined congruence.*

According to this definition, (4.9) represents an inclined congruence. Then, we have the following theorem.

Theorem 4.2 *Let S be a circle with two parameter on the unit dual sphere K The Study map of orthotomic of S is an inclined congruence with degree two.*

In other respect, we know that the shortest distance between the axis g of the cylinder and the lines of the spherical orthotomic congruence is c_2 . Therefore, this cylinder is the envelope of the lines of the spherical orthotomic congruence. So, we have the following theorem.

Theorem 4.3 *Let K be a unit dual sphere and*

$$S = \{ \vec{X} \mid \langle \vec{X}, \vec{G} \rangle = \cos(\varphi + \varepsilon\varphi^*) = \text{constant}, \vec{X} \in K, \vec{G} \in K \}$$

be a circle on K . Let ζ and g be the Study maps of spherical orthotomic of S and G , respectively. Then the lines of ζ has an envelope which is a circular cylinder whose axis is g and radius is c_2 .

In the case that $\psi^* = -\lambda_1$, $\varphi \neq 0$ and $\varphi^* \neq 0$ (4.9) reduces to

$$\frac{y_1^2}{c_1^2} + \frac{y_2^2}{c_1^2} - \frac{y_3^2}{k^2} = 1, k = c_2 \cot c_1 = \text{constant}, c_1 = \varphi, c_2 = \varphi^* \quad (4.10)$$

which represents an hyperboloid of one sheet.

Since ψ^* and λ_1 are two independent parameters, it can be said that the Study map of spherical orthotomic of S is, in general, a family of hyperboloids of one sheet with two parameters. Therefore we can give the following theorem.

Theorem 4.4 *Let S be a circle on the unit dual sphere K . Then the Study map of spherical orthotomic of S is a family of hyperboloid of one sheet with two parameters.*

4.1 The Case that $\varphi^* \neq 0$ and $\varphi = \frac{\pi}{2}$

In this case the lines of the spherical orthotomic congruence (4.9) orthogonally intersect the generators of the cylinder whose axis is g and the radius is φ^* . Since (4.8) reduces to

$$\begin{cases} y_1 = \varphi^* \sin \psi + v \cos \psi \\ y_2 = -\varphi^* \cos \psi + v \sin \psi \\ y_3 = \psi^* + \lambda_1 \end{cases} \quad (4.11)$$

Then (4.9) becomes

$$\begin{cases} y_1^2 + y_2^2 = c_2^2 + v^2 \\ y_3 = \psi^* + \lambda_1 \end{cases} \quad (4.12)$$

4.2 The Case that $\varphi^* \neq 0$ and $\varphi = 0$ (or $\varphi = \pi$)

In this case the lines of the spherical orthotomic congruence ζ coincide with the generators of the cylinder which is the envelope of the lines of φ . This means noting but the Study map of spherical orthotomic of S reduces to cylinder whose equations, from (4.8), are

$$\begin{cases} y_1^2 + y_2^2 = c_2^2 \\ y_3 = -v \end{cases}$$

4.3 The Case $\varphi^* = 0$ and $\varphi = 0$ (or $\varphi = \pi$)

In this case all of the lines of the spherical orthotomic congruence ζ are coincided with the line g . Indeed, in this case, (4.8) reduces to

$$\begin{cases} y_1^2 + y_2^2 = 0 \\ y_3 = -v \end{cases}$$

which represents the line g .

4.4 The Case $\varphi^* = 0$ and $\varphi \neq 0$

In this case, all of the lines of ζ intersect the axis g under the constant angle φ . So, we can say that the lines of the spherical orthotomic congruence ζ are the common lines of two linear line complexes [13]. From (4.8), the equations of ζ give us that

$$y_1^2 + y_2^2 - \frac{[y_3 - (\psi^* + \lambda_1)]^2}{[\cot c_1]^2} = 0.$$

4.5 The Case that $\varphi^* = 0$ and $\varphi = \frac{\pi}{2}$

In this case S is a great circle on K . Then all of the lines of ζ orthogonally intersect the axis g . This means that the spherical orthotomic inclined congruence reduces to a linear line complex whose axis is g . Then (4.8) gives us that the equation of ζ as

$$\begin{cases} y_1 = v \cos \psi \\ y_2 = v \sin \psi \\ y_3 = \lambda_1 + \psi^* \end{cases}$$

or

$$\begin{cases} y_1^2 + y_2^2 = v^2 \\ y_3 = \lambda_1 + \psi^* \end{cases}$$

Definition 4.5 *If all the lines of a line congruence orthogonally intersect a constant line then the congruence is called a recticongruence.*

Therefore we can give the following theorem.

Theorem 4.6 *Let S be a great circle on K , that is,*

$$S = \{ \vec{X} \mid \langle \vec{X}, \vec{G} \rangle = 0, \vec{X}, \vec{G} \in K \}.$$

Then the Study map ζ of orthotomic of S is a recticongruence.

In the case that $\lambda_1 = c_3\psi$ and (4.11) reduces to

$$\begin{cases} y_1 = v \cos \psi \\ y_2 = v \sin \psi \\ y_3 = c_3\psi \end{cases}$$

or

$$y_3 = c_3 \arctan \frac{y_2}{y_1}$$

which represents a right helicoid

Since λ_1 is a parameter, we can choose it as $\lambda_1 = c_3\psi$ and so under the corresponding

mapping the image of spherical orthotomic congruence reduce to a right helicoid. Hence we can give the following theorem.

Theorem 4.8 *It is possible to choose the Study mapping such that the Study maps of spherical orthotomic of dual circles are right helicoids.*

For the spherical orthotomic of great circle which lies on $Sp \{ \vec{E}_1, \vec{E}_3 \}$, we have the following theorem.

Theorem 4.9 *The Study map of spherical orthotomic of S is given by*

$$\frac{y_1^2}{c_2^2} + \frac{y_3^2}{c_2^2} - \frac{[y_2 - (\psi^* + \lambda_3)]^2}{[c_2 \cot c_1]^2} = 1$$

which has two parameters, so it represents a line congruence with degree two.

For a plane spanned by $\{ \vec{E}_2, \vec{E}_3 \}$, we obtain the following theorem.

Theorem 4.10 *The Study map of spherical orthotomic of S is given by*

$$\frac{y_2^2}{c_2^2} + \frac{y_3^2}{c_2^2} - \frac{[y_1 - (\psi^* + \lambda_2)]^2}{[c_2 \cot c_1]^2} = 1$$

which has two parameters, so it represents a line congruence with degree two.

By using the above two theorems, one way modify the study of this paper with choosing the plane spanned by $\{ \vec{E}_1, \vec{E}_3 \}$ or $\{ \vec{E}_2, \vec{E}_3 \}$.

References

- [1] N.Alamo, C.Criado, Generalized Antiorthotomics and their Singularities, *Inverse Problems*, 18(3) (2002) 881–889.
- [2] W.Blaschke, *Vorlesungen Über Differential Geometry I*, Verlag von Julius Springer in Berlin (1930) pp. 89.
- [3] J.W.Bruce, On singularities, envelopes and elementary differential geometry, *Math. Proc. Cambridge Philos. Soc.*, 89 (1) (1981) 43–48.
- [4] J.W.Bruce and P.J.Giblin, *Curves and Singularities: A Geometrical Introduction to Singularity Theory* (Second Edition), University Press, Cambridge, 1992.
- [5] J.W.Bruce and P.J.Giblin, One-parameter families of caustics by reflection in the plane, *Quart. J. Math. Oxford Ser. (2)*, 35(139) (1984) 243–251.
- [6] C.Georgiou, T.Hasanis and D.Koutroufiotis, On the caustic of a convex mirror, *Geom. Dedicata*, 28(2) (1988) 153–169.
- [7] C.G.Gibson, *Elementary Geometry of Differentiable Curves*, Cambridge University Press, May (2011).
- [8] H. Guggenheimer, Mc Graw-Hill Book Comp. Inc London, Lib. Cong. Cat. Card Numb.

- (1963) 63-12118.
- [9] H.H.Hacısalıhođlu, Acceleration axes in spatial kinematics I, *Communications de la Faculte des Sciences de L'Universite d'Ankara*, Serie A, Tome 20 A, Annee (1971) pp. L-15.
- [10] Ö. Köse, A Method of the determination of a developable ruled surface, *Mechanism and Machine Theory*, 34 (1999) 1187-1193.
- [11] Ö. Köse, Contributions to the theory of integral invariants of a closed ruled surface, *Mechanism and Machine Theory*, 32 (2) (1997) 261-277.
- [12] Ö. Köse, *Çizgiler Uzayında Yörünge Yüzeyleri*, Doctoral Dissertation, Atatürk University, Erzurum, (1975).
- [13] H.R. Müller, *Kinematik Dersleri*, Ankara University Press, pp. 247-267-271, 1963.
- [14] K.Nomizu, *Fundamentals of Linear Algebra*, Mc Graw-Hill, Book Company, London, Lib. Cong. Cat. Card Numb. 65-28732, 52-67, 1966.
- [15] E.Study, *Geometrie der Dynamen*, Leibzig, 1903.
- [16] J.F.Xiong, *Geometry and Singularities of Spatial and Spherical Curves*, The degree of Doctor of Philosophy, University of Hawai, Hawai, 2004.
- [17] J.F.Xiong, Spherical orthotomic and spherical antiorthotomic, *Acta Mathematica Sinica*, Vol.23, Issue 9, 1673-1682, September 2007.

Geometry on Non-Solvable Equations

– *A Review on Contradictory Systems*

Linfan MAO

(Chinese Academy of Mathematics and System Science, Beijing 100190, P.R.China)

E-mail: maolinfan@163.com

Abstract: As we known, an objective thing not moves with one's volition, which implies that all contradictions, particularly, in these semiotic systems for things are artificial. In classical view, a contradictory system is meaningless, contrast to that of geometry on figures of things caught by eyes of human beings. The main objective of sciences is holding the global behavior of things, which needs one knowing both of compatible and contradictory systems on things. Usually, a mathematical system including contradictions is said to be a *Smarandache system*. Beginning from a famous fable, i.e., the 6 blind men with an elephant, this report shows the geometry on contradictory systems, including non-solvable algebraic linear or homogenous equations, non-solvable ordinary differential equations and non-solvable partial differential equations, classify such systems and characterize their global behaviors by combinatorial geometry, particularly, the global stability of non-solvable differential equations. Applications of such systems to other sciences, such as those of gravitational fields, ecologically industrial systems can be also found in this report. All of these discussions show that a non-solvable system is nothing else but a system underlying a topological graph $G \not\cong K_n$, or $\simeq K_n$ without common intersection, contrast to those of solvable systems underlying K_n being with common non-empty intersections, where n is the number of equations in this system. However, if we stand on a geometrical viewpoint, they are compatible and both of them are meaningful for human beings.

Key Words: Smarandache system, non-solvable system of equations, topological graph, G^L -solution, global stability, ecologically industrial systems, gravitational field, mathematical combinatorics.

AMS(2010): 03A10,05C15,20A05, 34A26,35A01,51A05,51D20,53A35

§1. Introduction

A *contradiction* is a difference between two statements, beliefs, or ideas about something that can not both be true, exists everywhere and usually with a presentation as argument, debate, disputing, \dots , etc., even break out a war sometimes. Among them, a widely known contradiction in philosophy happened in a famous fable, i.e., the 6 blind men with an elephant following.

¹Reported at the *International Conference on Geometry and Its Applications*, Jardpour University, October 16-18, 2014, Kolkata, India.

²Received August 28, 2014, Accepted November 30, 2014.



Fig.1

In this fable, there are 6 blind men were asked to determine what an elephant looked like by feeling different parts of the elephant’s body. The man touched the elephant’s leg, tail, trunk, ear, belly or tusk respectively claims it’s like a pillar, a rope, a tree branch, a hand fan, a wall or a solid pipe, such as those shown in Fig.1. Each of them insisted on his own and not accepted others. They then entered into an endless argument. *All of you are right!* A wise man explains to them: *why are you telling it differently is because each one of you touched the different part of the elephant. So, actually the elephant has all those features what you all said.* Thus, the best result on an elephant for these blind men is

$$\begin{aligned} \text{An elephant} = & \{4 \text{ pillars}\} \cup \{1 \text{ rope}\} \cup \{1 \text{ tree branch}\} \\ & \cup \{2 \text{ hand fans}\} \cup \{1 \text{ wall}\} \cup \{1 \text{ solid pipe}\}, \end{aligned}$$

i.e., a *Smarandache multi-space* ([23]-[25]) defined following.

Definition 1.1([12]-[13]) *Let $(\Sigma_1; \mathcal{R}_1), (\Sigma_2; \mathcal{R}_2), \dots, (\Sigma_m; \mathcal{R}_m)$ be m mathematical systems, different two by two. A Smarandache multi-system $\tilde{\Sigma}$ is a union $\bigcup_{i=1}^m \Sigma_i$ with rules $\tilde{\mathcal{R}} = \bigcup_{i=1}^m \mathcal{R}_i$ on $\tilde{\Sigma}$, denoted by $(\tilde{\Sigma}; \tilde{\mathcal{R}})$.*

Then, what is the philosophical meaning of this fable for one understanding the world? In fact, the situation for one realizing behaviors of things is analogous to the blind men determining what an elephant looks like. Thus, this fable means the limitation or unilateral of one’s knowledge, i.e., *science* because of all of those are just correspondent with the sensory cognition of human beings.

Besides, we know that contradiction exists everywhere by this fable, which comes from the limitation of unilateral sensory cognition, i.e., artificial contradiction of human beings, and all scientific conclusions are nothing else but an approximation for things. For example, let $\mu_1, \mu_2, \dots, \mu_n$ be known and $\nu_i, i \geq 1$ unknown characters at time t for a thing T . Then, the

thing T should be understood by

$$T = \left(\bigcup_{i=1}^n \{\mu_i\} \right) \cup \left(\bigcup_{k \geq 1} \{\nu_k\} \right)$$

in logic but with an approximation $T^\circ = \bigcup_{i=1}^n \{\mu_i\}$ for T by human being at time t . Even for T° , these are maybe contradictions in characters $\mu_1, \mu_2, \dots, \mu_n$ with endless argument between researchers, such as those implied in the fable of 6 blind men with an elephant. Consequently, if one stands still on systems without contradictions, he will never hold the real face of things in the world, particularly, the true essence of geometry for limited of his time.

However, all things are inherently related, not isolated in philosophy, i.e., underlying an invariant topological structure G ([4],[22]). Thus, one needs to characterize those things on contradictory systems, particularly, by geometry. The main objective of this report is to discuss the geometry on contradictory systems, including non-solvable algebraic equations, non-solvable ordinary or partial differential equations, classify such systems and characterize their global behaviors by combinatorial geometry, particularly, the global stability of non-solvable differential equations. For terminologies and notations not mentioned here, we follow references [11], [13] for topological graphs, [3]-[4] for topology, [12],[23]-[25] for Smarandache multi-spaces and [2],[26] for partial or ordinary differential equations.

§2. Geometry on Non-Solvable Equations

Loosely speaking, a geometry is mainly concerned with shape, size, position, \dots etc., i.e., local or global characters of a figure in space. Its mainly objective is to hold the global behavior of things. However, things are always complex, even hybrid with other things. So it is difficult to know its global characters, or true face of a thing sometimes.

Let us beginning with two systems of linear equations in 2 variables:

$$(LES_4^S) \begin{cases} x + 2y = 4 \\ 2x + y = 5 \\ x - 2y = 0 \\ 2x - y = 3 \end{cases} \quad (LES_4^N) \begin{cases} x + 2y = 2 \\ x + 2y = -2 \\ 2x - y = -2 \\ 2x - y = 2 \end{cases}$$

Clearly, (LES_4^S) is solvable with a solution $x = 2$ and $y = 1$, but (LES_4^N) is not because $x + 2y = -2$ is contradictious to $x + 2y = 2$, and so that for equations $2x - y = -2$ and $2x - y = 2$. Thus, (LES_4^N) is a contradiction system, i.e., a Smarandache system defined following.

Definition 2.1([11]-[13]) *A rule in a mathematical system $(\Sigma; \mathcal{R})$ is said to be Smarandachely denied if it behaves in at least two different ways within the same set Σ , i.e., validated and invalided, or only invalided but in multiple distinct ways.*

A Smarandache system $(\Sigma; \mathcal{R})$ is a mathematical system which has at least one Smarandachely denied rule in \mathcal{R} .

In geometry, we are easily finding conditions for systems of equations solvable or not. For integers $m, n \geq 1$, denote by

$$S_{f_i} = \{(x_1, x_2, \dots, x_{n+1}) \mid f_i(x_1, x_2, \dots, x_{n+1}) = 0\} \subset \mathbb{R}^{n+1}$$

the solution-manifold in \mathbb{R}^{n+1} for integers $1 \leq i \leq m$, where f_i is a function hold with conditions of the implicit function theorem for $1 \leq i \leq m$. Clearly, the system

$$(ES_m) \left\{ \begin{array}{l} f_1(x_1, x_2, \dots, x_{n+1}) = 0 \\ \dots\dots\dots \\ f_m(x_1, x_2, \dots, x_{n+1}) = 0 \end{array} \right.$$

is solvable or not dependent on

$$\bigcap_{i=1}^m S_{f_i} \neq \emptyset \text{ or } = \emptyset.$$

Conversely, if \mathcal{D} is a geometrical space consisting of m manifolds $\mathcal{D}_1, \mathcal{D}_2, \dots, \mathcal{D}_m$ in \mathbb{R}^{n+1} , where,

$$\mathcal{D}_i = \{(x_1, x_2, \dots, x_{n+1}) \mid f_k^{[i]}(x_1, x_2, \dots, x_{n+1}) = 0, 1 \leq k \leq m_i\} = \bigcap_{k=1}^{m_i} S_{f_k^{[i]}}.$$

Then, the system

$$\left. \begin{array}{l} f_1^{[i]}(x_1, x_2, \dots, x_{n+1}) = 0 \\ \dots\dots\dots \\ f_{m_i}^{[i]}(x_1, x_2, \dots, x_{n+1}) = 0 \end{array} \right\} 1 \leq i \leq m$$

is solvable or not dependent on the intersection

$$\bigcap_{i=1}^m \mathcal{D}_i \neq \emptyset \text{ or } = \emptyset.$$

Thus, we obtain the following result.

Theorem 2.2 *If a geometrical space \mathcal{D} consists of m parts $\mathcal{D}_1, \mathcal{D}_2, \dots, \mathcal{D}_m$, where, $\mathcal{D}_i = \{(x_1, x_2, \dots, x_{n+1}) \mid f_k^{[i]}(x_1, x_2, \dots, x_{n+1}) = 0, 1 \leq k \leq m_i\}$, then the system (ES_m) consisting of*

$$\left. \begin{array}{l} f_1^{[i]}(x_1, x_2, \dots, x_{n+1}) = 0 \\ \dots\dots\dots \\ f_{m_i}^{[i]}(x_1, x_2, \dots, x_{n+1}) = 0 \end{array} \right\} 1 \leq i \leq m$$

is non-solvable if $\bigcap_{i=1}^m \mathcal{D}_i = \emptyset$.

Now, *whether is it meaningless for a contradiction system in the world?* Certainly not! As we discussed in the last section, a contradiction is artificial if such a system indeed exists in the world. The objective for human beings is not just finding contradictions, but holds behaviors of such systems. For example, although the system (LES_4^N) is contradictory, but it really exists, i.e., 4 lines in \mathbb{R}^2 , such as those shown in Fig.2.

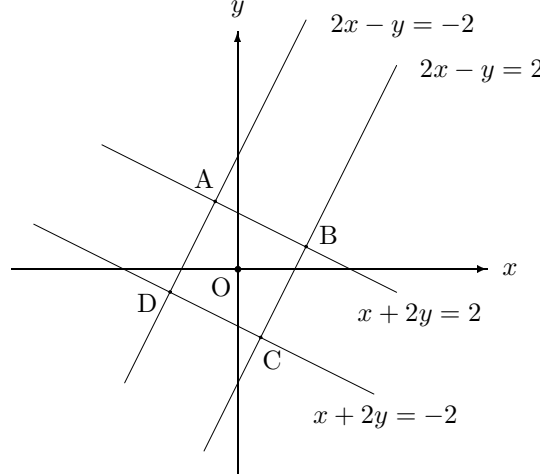

Fig.2

Generally, let

$$AX = (b_1, b_2, \dots, b_m)^T \quad (LEq)$$

be a linear equation system with

$$A = \begin{bmatrix} a_{11} & a_{12} & \cdots & a_{1n} \\ a_{21} & a_{22} & \cdots & a_{2n} \\ \cdots & \cdots & \cdots & \cdots \\ a_{m1} & a_{m2} & \cdots & a_{mn} \end{bmatrix} \quad \text{and} \quad X = \begin{bmatrix} x_1 \\ x_2 \\ \cdots \\ x_n \end{bmatrix}$$

for integers $m, n \geq 1$. A vertex-edge labeled graph $G^L[LEq]$ on such a system is defined by:

$V(G^L[LEq]) = \{P_1, P_2, \dots, P_m\}$, where $P_i = \{(x_1, x_2, \dots, x_n) | a_{i1}x_1 + a_{i2}x_2 + \dots + a_{in}x_n = b_i\}$, $E(G^L[LEq]) = \{(P_i, P_j), P_i \cap P_j \neq \emptyset, 1 \leq i, j \leq m\}$ and labeled with $L : P_i \rightarrow P_i$, $L : (P_i, P_j) \rightarrow P_i \cap P_j$ for integers $1 \leq i, j \leq m$ with an underlying graph $\widehat{G}[LEq]$ without labels.

For example, let $L_1 = \{(x, y) | x + 2y = 2\}$, $L_2 = \{(x, y) | x + 2y = -2\}$, $L_3 = \{(x, y) | 2x - y = 2\}$ and $L_4 = \{(x, y) | 2x - y = -2\}$ for the system (LES_4^N) . Clearly, $L_1 \cap L_2 = \emptyset$, $L_1 \cap L_3 = \{B\}$, $L_1 \cap L_4 = \{A\}$, $L_2 \cap L_3 = \{C\}$, $L_2 \cap L_4 = \{D\}$ and $L_3 \cap L_4 = \emptyset$. Then, the system (LES_4^N) can also appears as a vertex-edge labeled graph C_4^l in \mathbb{R}^2 with labels vertex labeling

$l(L_i) = L_i$ for integers $1 \leq i \leq 4$, edge labeling $l(L_1, L_3) = B$, $l(L_1, L_4) = A$, $l(L_2, L_3) = C$ and $l(L_2, L_4) = D$, such as those shown in Fig.3.

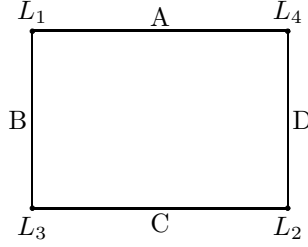

Fig.3

We are easily to determine $\widehat{G}[LEq]$ for systems (LEq) . For integers $1 \leq i, j \leq m$, $i \neq j$, two linear equations

$$\begin{aligned} a_{i1}x_1 + a_{i2}x_2 + \cdots + a_{in}x_n &= b_i, \\ a_{j1}x_1 + a_{j2}x_2 + \cdots + a_{jn}x_n &= b_j \end{aligned}$$

are called *parallel* if there exists a constant c such that

$$c = a_{j1}/a_{i1} = a_{j2}/a_{i2} = \cdots = a_{jn}/a_{in} \neq b_j/b_i.$$

Otherwise, *non-parallel*. The following result is known in [16].

Theorem 2.3([16]) *Let (LEq) be a linear equation system for integers $m, n \geq 1$. Then $\widehat{G}[LEq] \simeq K_{n_1, n_2, \dots, n_s}$ with $n_1 + n_2 + \cdots + n_s = m$, where \mathcal{C}_i is the parallel family by the property that all equations in a family \mathcal{C}_i are parallel and there are no other equations parallel to lines in \mathcal{C}_i for integers $1 \leq i \leq s$, $n_i = |\mathcal{C}_i|$ for integers $1 \leq i \leq s$ in (LEq) and (LEq) is non-solvable if $s \geq 2$.*

Particularly, for linear equation system on 2 variables, let H be a planar graph with edges straight segments on \mathbb{R}^2 . The *c-line graph* $L_C(H)$ on H is defined by

$$\begin{aligned} V(L_C(H)) &= \{\text{straight lines } L = e_1 e_2 \cdots e_l, s \geq 1 \text{ in } H\}; \\ E(L_C(H)) &= \{(L_1, L_2) \mid L_1 = e_1^1 e_2^1 \cdots e_l^1, L_2 = e_1^2 e_2^2 \cdots e_s^2, l, s \geq 1 \\ &\quad \text{and there adjacent edges } e_i^1, e_j^2 \text{ in } H, 1 \leq i \leq l, 1 \leq j \leq s\}. \end{aligned}$$

Then, a simple criterion in [16] following is interesting.

Theorem 2.4([16]) *A linear equation system $(LEq2)$ on 2 variables is non-solvable if and only if $\widehat{G}[LEq2] \simeq L_C(H)$, where H is a planar graph of order $|H| \geq 2$ on \mathbb{R}^2 with each edge a straight segment*

Generally, a Smarandache multi-system is equivalent to a combinatorial system by following, which implies the *CC Conjecture* for mathematics, i.e., *any mathematics can be recon-*

structed from or turned into combinatorization (see [6] for details).

Definition 2.5([11]-[13]) For any integer $m \geq 1$, let $(\tilde{\Sigma}; \tilde{\mathcal{R}})$ be a Smarandache multi-system consisting of m mathematical systems $(\Sigma_1; \mathcal{R}_1), (\Sigma_2; \mathcal{R}_2), \dots, (\Sigma_m; \mathcal{R}_m)$. An inherited topological structure $G^L[\tilde{S}]$ of $(\tilde{\Sigma}; \tilde{\mathcal{R}})$ is a topological vertex-edge labeled graph defined following:

$$\begin{aligned} V(G^L[\tilde{S}]) &= \{\Sigma_1, \Sigma_2, \dots, \Sigma_m\}, \\ E(G^L[\tilde{S}]) &= \{(\Sigma_i, \Sigma_j) \mid \Sigma_i \cap \Sigma_j \neq \emptyset, 1 \leq i \neq j \leq m\} \text{ with labeling} \\ L: \Sigma_i &\rightarrow L(\Sigma_i) = \Sigma_i \quad \text{and} \quad L: (\Sigma_i, \Sigma_j) \rightarrow L(\Sigma_i, \Sigma_j) = \Sigma_i \cap \Sigma_j \end{aligned}$$

for integers $1 \leq i \neq j \leq m$.

Therefore, a Smarandache system is equivalent to a combinatorial system, i.e., $(\tilde{\Sigma}; \tilde{\mathcal{R}}) \simeq G^L[\tilde{S}]$, a labeled graph $\widehat{G}^L[\tilde{S}]$ by this notion. For examples, denoting by $a = \{\text{tusk}\} b = \{\text{nose}\} c_1, c_2 = \{\text{ear}\} d = \{\text{head}\} e = \{\text{neck}\} f = \{\text{trunk}\} g_1, g_2, g_3, g_4 = \{\text{leg}\} h = \{\text{tail}\}$ for an elephant then a topological structure for an elephant is shown in Fig.4 following.

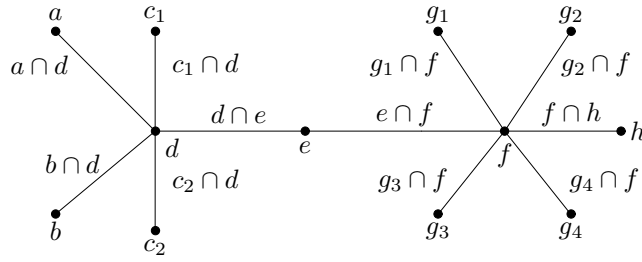

Fig.4 Topological structure of an elephant

For geometry, let these mathematical systems $(\Sigma_1; \mathcal{R}_1), (\Sigma_2; \mathcal{R}_2), \dots, (\Sigma_m; \mathcal{R}_m)$ be geometrical spaces, for instance manifolds M_1, M_2, \dots, M_m with respective dimensions n_1, n_2, \dots, n_m in Definition 2.3, we get a geometrical space $\widetilde{M} = \bigcup_{i=1}^m M_i$ underlying a topological graph $G^L[\widetilde{M}]$. Such a geometrical space $G^L[\widetilde{M}]$ is said to be *combinatorial manifold*, denoted by $\widetilde{M}(n_1, n_2, \dots, n_m)$. Particularly, if $n_i = n, 1 \leq i \leq m$, then a combinatorial manifold $\widetilde{M}(n_1, \dots, n_m)$ is nothing else but an n -manifold underlying $G^L[\widetilde{M}]$. However, this presentation of G^L -systems contributes to manifolds and combinatorial manifolds (See [7]-[15] for details). For example, the fundamental groups of manifolds are characterized in [14]-[15] following.

Theorem 2.6([14]) For any locally compact n -manifold M , there always exists an inherent graph $G_{min}^{in}[M]$ of M such that $\pi(M) \cong \pi(G_{min}^{in}[M])$.

Particularly, for an integer $n \geq 2$ a compact n -manifold M is simply-connected if and only if $G_{min}^{in}[M]$ is a finite tree.

Theorem 2.7([15]) Let \widetilde{M} be a finitely combinatorial manifold. If for $\forall(M_1, M_2) \in E(G^L[\widetilde{M}])$,

$M_1 \cap M_2$ is simply-connected, then

$$\pi_1(\widetilde{M}) \cong \left(\bigoplus_{M \in V(G[\widetilde{M}])} \pi_1(M) \right) \bigoplus \pi_1(G[\widetilde{M}]).$$

Furthermore, it provides one with a listing of manifolds by graphs in [14].

Theorem 2.8([14]) *Let $\mathcal{A}[M] = \{ (U_\lambda; \varphi_\lambda) \mid \lambda \in \Lambda \}$ be a atlas of a locally compact n -manifold M . Then the labeled graph $G_{|\Lambda|}^L$ of M is a topological invariant on $|\Lambda|$, i.e., if $H_{|\Lambda|}^{L_1}$ and $G_{|\Lambda|}^{L_2}$ are two labeled n -dimensional graphs of M , then there exists a self-homeomorphism $h : M \rightarrow M$ such that $h : H_{|\Lambda|}^{L_1} \rightarrow G_{|\Lambda|}^{L_2}$ naturally induces an isomorphism of graph.*

For a combinatorial surface consisting of surfaces associated with homogenous polynomials in \mathbb{R}^3 , we can further determine its genus. Let

$$P_1(\bar{x}), P_2(\bar{x}), \dots, P_m(\bar{x}) \quad (ES_m^{n+1})$$

be m homogeneous polynomials in variables x_1, x_2, \dots, x_{n+1} with coefficients in \mathbb{C} and

$$\emptyset \neq S_{P_i} = \{(x_1, x_2, \dots, x_{n+1}) \mid P_i(\bar{x}) = 0\} \subset \mathbb{P}^n \mathbb{C}$$

for integers $1 \leq i \leq m$, which are hypersurfaces, particularly, curves if $n = 2$ passing through the original of \mathbb{C}^{n+1} .

Similarly, parallel hypersurfaces in \mathbb{C}^{n+1} are defined following.

Definition 2.9 *Let $P(\bar{x}), Q(\bar{x})$ be two complex homogenous polynomials of degree d in $n + 1$ variables and $I(P, Q)$ the set of intersection points of $P(\bar{x})$ with $Q(\bar{x})$. They are said to be parallel, denoted by $P \parallel Q$ if $d > 1$ and there are constants a, b, \dots, c (not all zero) such that for $\forall \bar{x} \in I(P, Q)$, $ax_1 + bx_2 + \dots + cx_{n+1} = 0$, i.e., all intersections of $P(\bar{x})$ with $Q(\bar{x})$ appear at a hyperplane on $\mathbb{P}^n \mathbb{C}$, or $d = 1$ with all intersections at the infinite $x_{n+1} = 0$. Otherwise, $P(\bar{x})$ are not parallel to $Q(\bar{x})$, denoted by $P \not\parallel Q$.*

Then, these polynomials in (ES_m^{n+1}) can be classified into families $\mathcal{C}_1, \mathcal{C}_2, \dots, \mathcal{C}_l$ by this parallel property such that $P_i \parallel P_j$ if $P_i, P_j \in \mathcal{C}_k$ for an integer $1 \leq k \leq l$, where $1 \leq i \neq j \leq m$ and it is maximal if each \mathcal{C}_i is maximal for integers $1 \leq i \leq l$, i.e., for $\forall P \in \{P_k(\bar{x}), 1 \leq k \leq m\} \setminus \mathcal{C}_i$, there is a polynomial $Q(\bar{x}) \in \mathcal{C}_i$ such that $P \not\parallel Q$. The following result is a generalization of Theorem 2.3.

Theorem 2.10([19]) *Let $n \geq 2$ be an integer. For a system (ES_m^{n+1}) of homogenous polynomials with a parallel maximal classification $\mathcal{C}_1, \mathcal{C}_2, \dots, \mathcal{C}_l$,*

$$\widehat{G}[ES_m^{n+1}] \leq K(\mathcal{C}_1, \mathcal{C}_2, \dots, \mathcal{C}_l)$$

and with equality holds if and only if $P_i \parallel P_j$ and $P_s \not\parallel P_i$ implies that $P_s \not\parallel P_j$, where

$K(\mathcal{C}_1, \mathcal{C}_2, \dots, \mathcal{C}_l)$ denotes a complete l -partite graphs. Conversely, for any subgraph $G \leq K(\mathcal{C}_1, \mathcal{C}_2, \dots, \mathcal{C}_l)$, there are systems (ES_m^{n+1}) of homogenous polynomials with a parallel maximal classification $\mathcal{C}_1, \mathcal{C}_2, \dots, \mathcal{C}_l$ such that

$$G \simeq \widehat{G}[ES_m^{n+1}].$$

Particularly, if all polynomials in (ES_m^{n+1}) be degree 1, i.e., hyperplanes with a parallel maximal classification $\mathcal{C}_1, \mathcal{C}_2, \dots, \mathcal{C}_l$, then

$$\widehat{G}[ES_m^{n+1}] = K(\mathcal{C}_1, \mathcal{C}_2, \dots, \mathcal{C}_l).$$

The following result is immediately known by definition.

Theorem 2.11 Let (ES_m^{n+1}) be a G^L -system consisting of homogenous polynomials $P(\bar{x}_1), P(\bar{x}_2), \dots, P(\bar{x}_m)$ in $n+1$ variables with respectively hypersurfaces $S_{P_i}, 1 \leq i \leq m$. Then, $\widetilde{M} = \bigcup_{i=1}^m S_{P_i}$ is an n -manifold underlying graph $\widehat{G}[ES_m^{n+1}]$ in \mathbb{C}^{n+1} .

For $n = 2$, we can further determine the genus of surface \widetilde{M} in \mathbb{R}^3 following.

Theorem 2.12([19]) Let \widetilde{S} be a combinatorial surface consisting of m orientable surfaces S_1, S_2, \dots, S_m underlying a topological graph $G^L[\widetilde{S}]$ in \mathbb{R}^3 . Then

$$g(\widetilde{S}) = \beta(\widehat{G}\langle\widetilde{S}\rangle) + \sum_{i=1}^m (-1)^{i+1} \sum_{\bigcap_{l=1}^i S_{k_l} \neq \emptyset} \left[g\left(\bigcap_{l=1}^i S_{k_l}\right) - c\left(\bigcap_{l=1}^i S_{k_l}\right) + 1 \right],$$

where $g\left(\bigcap_{l=1}^i S_{k_l}\right)$, $c\left(\bigcap_{l=1}^i S_{k_l}\right)$ are respectively the genus and number of path-connected components in surface $S_{k_1} \cap S_{k_2} \cap \dots \cap S_{k_i}$ and $\beta(\widehat{G}\langle\widetilde{S}\rangle)$ denotes the Betti number of topological graph $\widehat{G}\langle\widetilde{S}\rangle$.

Notice that for a curve C determined by homogenous polynomial $P(x, y, z)$ of degree d in $\mathbb{P}^2\mathbf{C}$, there is a compact connected Riemann surface S by the Noether's result such that

$$h : S - h^{-1}(\text{Sing}(C)) \rightarrow C - \text{Sing}(C)$$

is a homeomorphism with genus

$$g(S) = \frac{1}{2}(d-1)(d-2) - \sum_{p \in \text{Sing}(C)} \delta(p),$$

where $\delta(p)$ is a positive integer associated with the singular point p in C . Furthermore, if $\text{Sing}(C) = \emptyset$, i.e., C is non-singular then there is a compact connected Riemann surface S homeomorphism to C with genus $\frac{1}{2}(d-1)(d-2)$. By Theorem 2.12, we obtain the genus of \widetilde{S}

determined by homogenous polynomials following.

Theorem 2.13([19]) *Let C_1, C_2, \dots, C_m be complex curves determined by homogenous polynomials $P_1(x, y, z), P_2(x, y, z), \dots, P_m(x, y, z)$ without common component, and let*

$$R_{P_i, P_j} = \prod_{k=1}^{\deg(P_i)\deg(P_j)} (c_k^{ij}z - b_k^{ij}y)^{e_k^{ij}}, \quad \omega_{i,j} = \sum_{k=1}^{\deg(P_i)\deg(P_j)} \sum_{e_k^{ij} \neq 0} 1$$

be the resultant of $P_i(x, y, z), P_j(x, y, z)$ for $1 \leq i \neq j \leq m$. Then there is an orientable surface \tilde{S} in \mathbb{R}^3 of genus

$$\begin{aligned} g(\tilde{S}) &= \beta(\widehat{G} \langle \tilde{C} \rangle) + \sum_{i=1}^m \left(\frac{(\deg(P_i) - 1)(\deg(P_i) - 2)}{2} - \sum_{p^i \in \text{Sing}(C_i)} \delta(p^i) \right) \\ &+ \sum_{1 \leq i \neq j \leq m} (\omega_{i,j} - 1) + \sum_{i \geq 3} (-1)^i \sum_{C_{k_1} \cap \dots \cap C_{k_i} \neq \emptyset} \left[c(C_{k_1} \cap \dots \cap C_{k_i}) - 1 \right] \end{aligned}$$

with a homeomorphism $\varphi : \tilde{S} \rightarrow \tilde{C} = \bigcup_{i=1}^m C_i$. Furthermore, if C_1, C_2, \dots, C_m are non-singular, then

$$\begin{aligned} g(\tilde{S}) &= \beta(\widehat{G} \langle \tilde{C} \rangle) + \sum_{i=1}^m \frac{(\deg(P_i) - 1)(\deg(P_i) - 2)}{2} \\ &+ \sum_{1 \leq i \neq j \leq m} (\omega_{i,j} - 1) + \sum_{i \geq 3} (-1)^i \sum_{C_{k_1} \cap \dots \cap C_{k_i} \neq \emptyset} \left[c(C_{k_1} \cap \dots \cap C_{k_i}) - 1 \right], \end{aligned}$$

where

$$\delta(p^i) = \frac{1}{2} \left(I_{p^i} \left(P_i, \frac{\partial P_i}{\partial y} \right) - \nu_\phi(p^i) + |\pi^{-1}(p^i)| \right)$$

is a positive integer with a ramification index $\nu_\phi(p^i)$ for $p^i \in \text{Sing}(C_i), 1 \leq i \leq m$.

Notice that $\widehat{G} [ES_m^3] = K_m$. We then easily get conclusions following.

Corollary 2.14 *Let C_1, C_2, \dots, C_m be complex non-singular curves determined by homogenous polynomials $P_1(x, y, z), P_2(x, y, z), \dots, P_m(x, y, z)$ without common component, any intersection point $p \in I(P_i, P_j)$ with multiplicity 1 and*

$$\begin{cases} P_i(x, y, z) = 0 \\ P_j(x, y, z) = 0, \quad \forall i, j, k \in \{1, 2, \dots, m\} \\ P_k(x, y, z) = 0 \end{cases}$$

has zero-solution only. Then the genus of normalization \tilde{S} of curves C_1, C_2, \dots, C_m is

$$g(\tilde{S}) = 1 + \frac{1}{2} \times \sum_{i=1}^m \deg(P_i) (\deg(P_i) - 3) + \sum_{1 \leq i \neq j \leq m} \deg(P_i) \deg(P_j).$$

Corollary 2.15 *Let C_1, C_2, \dots, C_m be complex non-singular curves determined by homogenous polynomials $P_1(x, y, z), P_2(x, y, z), \dots, P_m(x, y, z)$ without common component and $C_i \cap C_j = \bigcap_{i=1}^m C_i$ with $\left| \bigcap_{i=1}^m C_i \right| = \kappa > 0$ for integers $1 \leq i \neq j \leq m$. Then the genus of normalization \tilde{S} of curves C_1, C_2, \dots, C_m is*

$$g(\tilde{S}) = g(\tilde{S}) = (\kappa - 1)(m - 1) + \sum_{i=1}^m \frac{(\deg(P_i) - 1)(\deg(P_i) - 2)}{2}.$$

Particularly, if all curves in \mathbb{C}^3 are lines, we know an interesting result following.

Corollary 2.16 *Let L_1, L_2, \dots, L_m be distinct lines in $\mathbb{P}^2\mathbb{C}$ with respective normalizations of spheres S_1, S_2, \dots, S_m . Then there is a normalization of surface \tilde{S} of L_1, L_2, \dots, L_m with genus $\beta(\widehat{G} \langle \tilde{L} \rangle)$. Particularly, if $\widehat{G} \langle \tilde{L} \rangle$ is a tree, then \tilde{S} is homeomorphic to a sphere.*

§3. Geometry on Non-Solvable Differential Equations

Why the system (ES_m) consisting of

$$\left. \begin{array}{l} f_1^{[i]}(x_1, x_2, \dots, x_n) = 0 \\ f_2^{[i]}(x_1, x_2, \dots, x_n) = 0 \\ \dots\dots\dots \\ f_{m_i}^{[i]}(x_1, x_2, \dots, x_n) = 0 \end{array} \right\} 1 \leq i \leq m$$

is non-solvable if $\bigcap_{i=1}^m \mathcal{D}_i = \emptyset$ in Theorem 2.2? In fact, it lies in that the solution-manifold of (ES_m) is the intersection of $\mathcal{D}_i, 1 \leq i \leq m$. If it is allowed combinatorial manifolds to be solution-manifolds, then there are no contradictions once more even if $\bigcap_{i=1}^m \mathcal{D}_i = \emptyset$. This fact implies that including combinatorial manifolds to be solution-manifolds of systems (ES_m) is a better understanding things in the world.

3.1 G^L -Systems of Differential Equations

Let

$$\left\{ \begin{array}{l} F_1(x_1, x_2, \dots, x_n, u, u_{x_1}, \dots, u_{x_n}) = 0 \\ F_2(x_1, x_2, \dots, x_n, u, u_{x_1}, \dots, u_{x_n}) = 0 \\ \dots\dots\dots \\ F_m(x_1, x_2, \dots, x_n, u, u_{x_1}, \dots, u_{x_n}) = 0 \end{array} \right. \quad (PDES_m)$$

be a system of ordinary or partial differential equations of first order on a function $u(x_1, \dots, x_n, t)$

partial differential equations with initial values $u|_{x_n=x_n^0} = u_0$ is non-solvable if and only if the system $(LPDES_m)$ of partial differential equations is algebraically contradictory. Particularly, the Cauchy problem on a quasilinear partial differential equation is always solvable.

Similarly, for integers $m, n \geq 1$, let

$$\dot{X} = A_1 X, \dots, \dot{X} = A_k X, \dots, \dot{X} = A_m X \quad (LDES_m^1)$$

be a linear ordinary differential equation system of first order and

$$\begin{cases} x^{(n)} + a_{11}^{[0]} x^{(n-1)} + \dots + a_{1n}^{[0]} x = 0 \\ x^{(n)} + a_{21}^{[0]} x^{(n-1)} + \dots + a_{2n}^{[0]} x = 0 \\ \dots\dots\dots \\ x^{(n)} + a_{m1}^{[0]} x^{(n-1)} + \dots + a_{mn}^{[0]} x = 0 \end{cases} \quad (LDE_m^n)$$

a linear differential equation system of order n with

$$A_k = \begin{bmatrix} a_{11}^{[k]} & a_{12}^{[k]} & \dots & a_{1n}^{[k]} \\ a_{21}^{[k]} & a_{22}^{[k]} & \dots & a_{2n}^{[k]} \\ \dots & \dots & \dots & \dots \\ a_{n1}^{[k]} & a_{n2}^{[k]} & \dots & a_{nn}^{[k]} \end{bmatrix} \quad \text{and} \quad X = \begin{bmatrix} x_1(t) \\ x_2(t) \\ \dots \\ x_n(t) \end{bmatrix}$$

where each $a_{ij}^{[k]}$ is a real number for integers $0 \leq k \leq m, 1 \leq i, j \leq n$. Then it is known a criterion from [16] following.

Theorem 3.4([17]) *A differential equation system $(LDES_m^1)$ is non-solvable if and only if*

$$(|A_1 - \lambda I_{n \times n}|, |A_2 - \lambda I_{n \times n}|, \dots, |A_m - \lambda I_{n \times n}|) = 1.$$

Similarly, the differential equation system (LDE_m^n) is non-solvable if and only if

$$(P_1(\lambda), P_2(\lambda), \dots, P_m(\lambda)) = 1,$$

where $P_i(\lambda) = \lambda^n + a_{i1}^{[0]} \lambda^{n-1} + \dots + a_{i(n-1)}^{[0]} \lambda + a_{in}^{[0]}$ for integers $1 \leq i \leq m$. Particularly, $(LDES_m^1)$ and (LDE_m^n) are always solvable.

According to Theorems 3.3 and 3.4, for systems $(LPDES_m^C)$, $(LDES_m^1)$ or (LDE_m^n) , there are equivalent systems $G^L[LPDES_m^C]$, $G^L[LDES_m^1]$ or $G^L[LDE_m^n]$ by Definition 2.5, called $G^L[LPDES_m^C]$ -solution, $G^L[LDES_m^1]$ -solution or $G^L[LDE_m^n]$ -solution of systems $(LPDES_m^C)$, $(LDES_m^1)$ or (LDE_m^n) , respectively. Then, we know the following conclusion from [17]-[18], [21].

Theorem 3.5([17]-[18],[21]) *The Cauchy problem on system $(PDES_m)$ of partial differential equations of first order with initial values $x_i^{[k^0]}, u_0^{[k]}, p_i^{[k^0]}$, $1 \leq i \leq n$ for the k th equation in*

($PDES_m$), $1 \leq k \leq m$ such that

$$\frac{\partial u_0^{[k]}}{\partial s_j} - \sum_{i=0}^n p_i^{[k^0]} \frac{\partial x_i^{[k^0]}}{\partial s_j} = 0,$$

and the linear homogeneous differential equation system ($LDES_m^1$) (or (LDE_m^n)) both are uniquely G^L -solvable, i.e., $G^L[PDES]$, $G^L[LDES_m^1]$ and $G^L[LDE_m^n]$ are uniquely determined.

For ordinary differential systems ($LDES_m^1$) or (LDE_m^n), we can further replace solution-manifolds $S^{[k]}$ of the k th equation in $G^L[LDES_m^1]$ and $G^L[LDE_m^n]$ by their solution basis $\mathcal{B}^{[k]} = \{ \bar{\beta}_i^{[k]}(t)e^{\alpha_i^{[k]}t} \mid 1 \leq i \leq n \}$ or $\mathcal{C}^{[k]} = \{ t^l e^{\lambda_i^{[k]}t} \mid 1 \leq i \leq s, 1 \leq l \leq k_i \}$ because each solution-manifold of ($LDES_m^1$) (or (LDE_m^n)) is a linear space.

For example, let a system (LDE_m^n) be

$$\begin{cases} \ddot{x} - 3\dot{x} + 2x = 0 & (1) \\ \ddot{x} - 5\dot{x} + 6x = 0 & (2) \\ \ddot{x} - 7\dot{x} + 12x = 0 & (3) \\ \ddot{x} - 9\dot{x} + 20x = 0 & (4) \\ \ddot{x} - 11\dot{x} + 30x = 0 & (5) \\ \ddot{x} - 7\dot{x} + 6x = 0 & (6) \end{cases}$$

where $\ddot{x} = \frac{d^2x}{dt^2}$ and $\dot{x} = \frac{dx}{dt}$. Then the solution basis of equations (1) – (6) are respectively $\{e^t, e^{2t}\}$, $\{e^{2t}, e^{3t}\}$, $\{e^{3t}, e^{4t}\}$, $\{e^{4t}, e^{5t}\}$, $\{e^{5t}, e^{6t}\}$, $\{e^{6t}, e^t\}$ with its $G^L[LDE_m^n]$ shown in Fig.5.

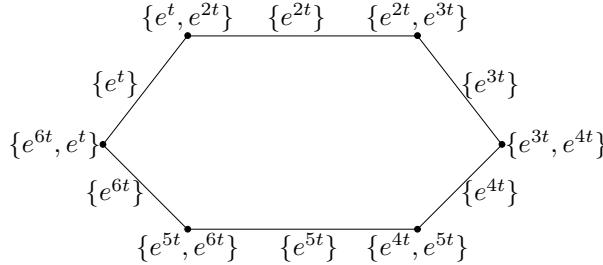

Fig.5

Such a labeling can be simplified to labeling by integers for combinatorially classifying systems $G^L[LDES_m^1]$ and $G^L[LDE_m^n]$, i.e., *integral graphs* following.

Definition 3.6 Let G be a simple graph. A vertex-edge labeled graph $\theta : G \rightarrow \mathbb{Z}^+$ is called *integral* if $\theta(uv) \leq \min\{\theta(u), \theta(v)\}$ for $\forall uv \in E(G)$, denoted by G^{I_θ} .

For two integral labeled graphs $G_1^{I_\theta}$ and $G_2^{I_\tau}$, they are called *identical* if $G_1 \stackrel{\varphi}{\cong} G_2$ and $\theta(x) = \tau(\varphi(x))$ for any graph isomorphism φ and $\forall x \in V(G_1) \cup E(G_1)$, denoted by $G_1^{I_\theta} = G_2^{I_\tau}$. Otherwise, *non-identical*.

For example, the graphs shown in Fig.6 are all integral on $K_4 - e$, but $G_1^{I_\theta} = G_2^{I_\tau}$, $G_1^{I_\theta} \neq G_3^{I_\sigma}$.

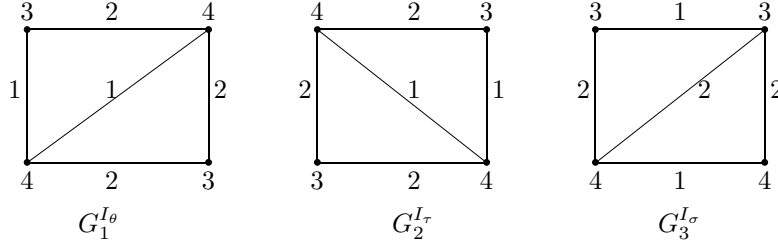

Fig.6

Applying integral graphs, the systems $(LDES_m^1)$ and (LDE_m^n) are combinatorially classified in [17] following.

Theorem 3.7([17]) *Let $(LDES_m^1)$, $(LDES_m^1)'$ (or (LDE_m^n) , $(LDE_m^n)'$) be two linear homogeneous differential equation systems with integral labeled graphs H, H' . Then $(LDES_m^1) \stackrel{\cong}{\simeq} (LDES_m^1)'$ (or $(LDE_m^n) \stackrel{\cong}{\simeq} (LDE_m^n)'$) if and only if $H = H'$.*

3.2 Differential Manifolds on G^L -Systems of Equations

By definition, the union $\widetilde{M} = \bigcup_{k=1}^m S^{[k]}$ is an n -manifold. The following result is immediately known.

Theorem 3.8([17]-[18],[21]) *For any simply graph G , there are differentiable solution-manifolds of $(PDES_m)$, $(LDES_m^1)$, (LDE_m^n) such that $\widehat{G}[PDES] \simeq G$, $\widehat{G}[LDES_m^1] \simeq G$ and $\widehat{G}[LDE_m^n] \simeq G$.*

Notice that a basis on vector field $T(M)$ of a differentiable n -manifold M is

$$\left\{ \frac{\partial}{\partial x_i}, 1 \leq i \leq n \right\}$$

and a vector field X can be viewed as a first order partial differential operator

$$X = \sum_{i=1}^n a_i \frac{\partial}{\partial x_i},$$

where a_i is C^∞ -differentiable for all integers $1 \leq i \leq n$. Combining Theorems 3.5 and 3.8 enables one to get a result on vector fields following.

Theorem 3.9([21]) *For an integer $m \geq 1$, let $U_i, 1 \leq i \leq m$ be open sets in \mathbb{R}^n underlying a graph defined by $V(G) = \{U_i | 1 \leq i \leq m\}$, $E(G) = \{(U_i, U_j) | U_i \cap U_j \neq \emptyset, 1 \leq i, j \leq m\}$. If X_i is a vector field on U_i for integers $1 \leq i \leq m$, then there always exists a differentiable manifold*

$M \subset \mathbb{R}^n$ with atlas $\mathcal{A} = \{(U_i, \phi_i) | 1 \leq i \leq m\}$ underlying graph G and a function $u_G \in \Omega^0(M)$ such that $X_i(u_G) = 0, 1 \leq i \leq m$.

§4. Applications

In philosophy, every thing is a G^L -system with contradictions embedded in our world, which implies that the geometry on non-solvable system of equations is in fact a truthful portraying of things with applications to various fields, particularly, the understanding on gravitational fields and the controlling of industrial systems.

4.1 Gravitational Fields

An immediate application of geometry on G^L -systems of non-solvable equations is that it can provides one with a visualization on things in space of dimension ≥ 4 by decomposing the space into subspaces underlying a graph G^L . For example, a decomposition of a Euclidean space into \mathbb{R}^3 is shown in Fig.7, where $G^L \simeq K_4$, a complete graph of order 4 and $\mathcal{P}_1, \mathcal{P}_2, \mathcal{P}_3, \mathcal{P}_4$ are the observations on its subspaces \mathbb{R}^3 . This space model enable one to hold well local behaviors of the spacetime in \mathbb{R}^3 as usual and then determine its global behavior naturally, different from the *string theory* by artificial assuming the dimension of the universe is 11.

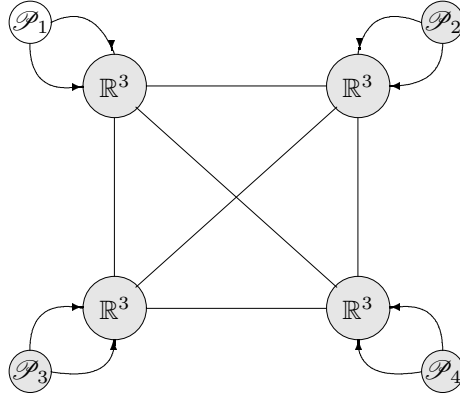

Fig.7

Notice that \mathbb{R}^3 is in a general position and maybe $\mathbb{R}^3 \cap \mathbb{R}^3 \neq \mathbb{R}^3$ here. Generally, if $G^L \simeq K_m$, we know its dimension following.

Theorem 4.1([9],[13]) Let $\mathcal{E}_{K_m}(3)$ be a K_m -space of $\underbrace{\mathbb{R}_1^3, \dots, \mathbb{R}^3}_m$. Then its minimum dimension

$$\dim_{min} \mathcal{E}_{K_m}(3) = \begin{cases} 3, & \text{if } m = 1, \\ 4, & \text{if } 2 \leq m \leq 4, \\ 5, & \text{if } 5 \leq m \leq 10, \\ 2 + \lceil \sqrt{m} \rceil, & \text{if } m \geq 11 \end{cases}$$

and maximum dimension

$$\dim_{\max} \mathcal{E}_{K_m}(3) = 2m - 1$$

with $\mathbb{R}_i^3 \cap \mathbb{R}_j^3 = \bigcap_{i=1}^m \mathbb{R}_i^3$ for any integers $1 \leq i, j \leq m$.

For the gravitational field, by applying the *geometrization of gravitation* in \mathbb{R}^3 , Einstein got his gravitational equations with time ([1])

$$R^{\mu\nu} - \frac{1}{2}Rg^{\mu\nu} + \lambda g^{\mu\nu} = -8\pi GT^{\mu\nu}$$

where $R^{\mu\nu} = R_{\alpha}^{\mu\alpha\nu} = g_{\alpha\beta}R^{\alpha\mu\beta\nu}$, $R = g_{\mu\nu}R^{\mu\nu}$ are the respective Ricci tensor, Ricci scalar curvature, $G = 6.673 \times 10^{-8} \text{cm}^3/\text{gs}^2$, $\kappa = 8\pi G/c^4 = 2.08 \times 10^{-48} \text{cm}^{-1} \cdot \text{g}^{-1} \cdot \text{s}^2$, which has a spherically symmetric solution on Riemannian metric, called *Schwarzschild spacetime*

$$ds^2 = f(t) \left(1 - \frac{r_s}{r}\right) dt^2 - \frac{1}{1 - \frac{r_s}{r}} dr^2 - r^2(d\theta^2 + \sin^2\theta d\phi^2)$$

for $\lambda = 0$ in vacuum, where r_g is the *Schwarzschild radius*. Thus, if the dimension of the universe ≥ 4 , all these observations are nothing else but a projection of the true faces on our six organs, a pseudo-truth. However, we can characterize its global behavior by K_m^L -space solutions of \mathbb{R}^3 (See [8]-[10] for details). For example, if $m = 4$, there are 4 Einstein's gravitational equations for $\forall v \in V(K_4^L)$. We can solving it locally by spherically symmetric solutions in \mathbb{R}^3 and construct a K_4^L -solution $S_{f_1}, S_{f_2}, S_{f_3}$ and S_{f_4} , such as those shown in Fig.8,

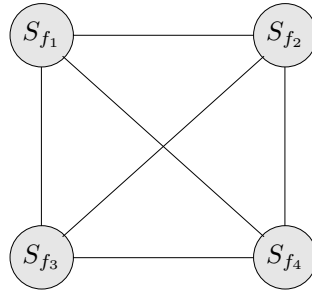

Fig.8

where, each S_{f_i} is a geometrical space determined by Schwarzschild spacetime

$$ds^2 = f(t) \left(1 - \frac{r_s}{r}\right) dt^2 - \frac{1}{1 - \frac{r_s}{r}} dr^2 - r^2(d\theta^2 + \sin^2\theta d\phi^2)$$

for integers $1 \leq i \leq m$. Certainly, its global behavior depends on the intersections $S_{f_i} \cap S_{f_j}$, $1 \leq i \neq j \leq 4$.

4.2 Ecologically Industrial Systems

Determining a system, particularly, an industrial system on initial values being stable or not is

an important problem because it reveals that this system is controllable or not by human beings. Usually, such a system is characterized by a system of differential equations. For example, let

$$\begin{cases} A \rightarrow X \\ 2X + Y \rightarrow 3X \\ B + X \rightarrow Y + D \\ X \rightarrow E \end{cases}$$

be the *Brusselator model* on chemical reaction, where A, B, X, Y are respectively the concentrations of 4 materials in this reaction. By the chemical dynamics if the initial concentrations for A, B are chosen sufficiently larger, then X and Y can be characterized by differential equations

$$\frac{\partial X}{\partial t} = k_1 \Delta X + A + X^2 Y - (B + 1)X, \quad \frac{\partial Y}{\partial t} = k_2 \Delta Y + BX - X^2 Y.$$

As we known, the stability of a system is determined by its solutions in classical sciences. But if the system of equations is non-solvable, *what is its stability?* It should be noted that non-solvable systems of equations extensively exist in our daily life. For example, an industrial system with raw materials M_1, M_2, \dots, M_n , products (including by-products) P_1, P_2, \dots, P_m but W_1, W_2, \dots, W_s wastes after a produce process, such as those shown in Fig.9 following,

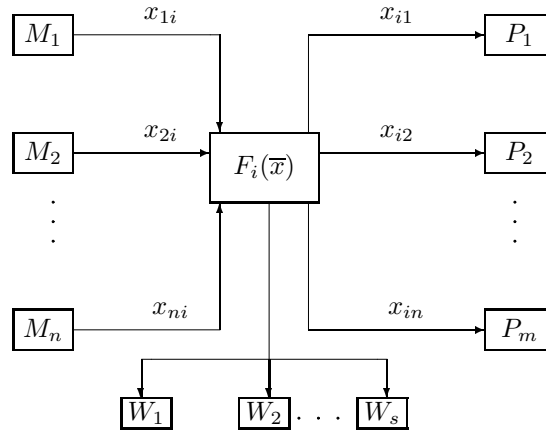

Fig.9

which is an opened system and can be transferred to a closed one by letting the environment as an additional cell, called an *ecologically industrial system*. However, such an ecologically industrial system is usually a non-solvable system of equations by the input-output model in economy, see [20] for details.

Certainly, the global stability depends on the local stabilities. Applying the G -solution of a G^L -system (DES_m^C) of differential equations, the global stability is defined following.

Definition 4.2 Let $(PDES_m^C)$ be a Cauchy problem on a system of partial differential equations of first order in \mathbb{R}^n , $H \leq G[PDES_m^C]$ a spanning subgraph, and $u^{[v]}$ the solution of the v th

equation with initial value $u_0^{[v]}$, $v \in V(H)$. It is sum-stable on the subgraph H if for any number $\varepsilon > 0$ there exists, $\delta_v > 0$, $v \in V(H)$ such that each $G(t)$ -solution with

$$\left| u_0'^{[v]} - u_0^{[v]} \right| < \delta_v, \quad \forall v \in V(H)$$

exists for all $t \geq 0$ and with the inequality

$$\left| \sum_{v \in V(H)} u'^{[v]} - \sum_{v \in V(H)} u^{[v]} \right| < \varepsilon$$

holds, denoted by $G[t] \overset{H}{\sim} G[0]$ and $G[t] \overset{\Sigma}{\sim} G[0]$ if $H = G[PDES_m^C]$. Furthermore, if there exists a number $\beta_v > 0$, $v \in V(H)$ such that every $G'[t]$ -solution with

$$\left| u_0'^{[v]} - u_0^{[v]} \right| < \beta_v, \quad \forall v \in V(H)$$

satisfies

$$\lim_{t \rightarrow \infty} \left| \sum_{v \in V(H)} u'^{[v]} - \sum_{v \in V(H)} u^{[v]} \right| = 0,$$

then the $G[t]$ -solution is called asymptotically stable, denoted by $G[t] \overset{H}{\rightarrow} G[0]$ and $G[t] \overset{\Sigma}{\rightarrow} G[0]$ if $H = G[PDES_m^C]$.

Let $(PDES_m^C)$ be a system

$$\left. \begin{aligned} \frac{\partial u}{\partial t} &= H_i(t, x_1, \dots, x_{n-1}, p_1, \dots, p_{n-1}) \\ u|_{t=t_0} &= u_0^{[i]}(x_1, x_2, \dots, x_{n-1}) \end{aligned} \right\} 1 \leq i \leq m \quad (APDES_m^C)$$

A point $X_0^{[i]} = (t_0, x_{10}^{[i]}, \dots, x_{(n-1)0}^{[i]})$ with $H_i(t_0, x_{10}^{[i]}, \dots, x_{(n-1)0}^{[i]}) = 0$ for an integer $1 \leq i \leq m$ is called an *equilibrium point* of the i th equation in $(APDES_m)$. A result on the sum-stability of $(APDES_m)$ is known in [18] and [21] following.

Theorem 4.3([18],[21]) *Let $X_0^{[i]}$ be an equilibrium point of the i th equation in $(APDES_m)$ for each integer $1 \leq i \leq m$. If*

$$\sum_{i=1}^m H_i(X) > 0 \quad \text{and} \quad \sum_{i=1}^m \frac{\partial H_i}{\partial t} \leq 0$$

for $X \neq \sum_{i=1}^m X_0^{[i]}$, then the system $(APDES_m)$ is sum-stability, i.e., $G[t] \overset{\Sigma}{\sim} G[0]$. Furthermore, if

$$\sum_{i=1}^m \frac{\partial H_i}{\partial t} < 0$$

for $X \neq \sum_{i=1}^m X_0^{[i]}$, then $G[t] \overset{\Sigma}{\rightarrow} G[0]$.

Particularly, if the non-solvable system is a linear homogenous differential equation systems ($LDES_m^1$), we further get a simple criterion on its zero G^L -solution, i.e., all vertices with 0 labels in [17] following.

Theorem 4.4([17]) *The zero G -solution of linear homogenous differential equation systems ($LDES_m^1$) is asymptotically sum-stable on a spanning subgraph $H \leq G[LDES_m^1]$ if and only if $\text{Re}\alpha_v < 0$ for each $\bar{\beta}_v(t)e^{\alpha_v t} \in \mathcal{B}_v$ in ($LDES^1$) hold for $\forall v \in V(H)$.*

§5. Conclusions

For human beings, the world is hybrid and filled with contradictions. That is why it is said that *all contradictions are artificial or man-made, not the nature of world* in this paper. In philosophy, a mathematics is nothing else but a set of *symbolic names with relations*. However, as *Lao Zi* said *name named is not the eternal name, the unnamable is the eternally real and naming is the origin of things* for human beings in his *TAO TEH KING*, a well-known Chinese book. It is difficult to establish such a mathematics join tightly with the world. Even so, for knowing the world, one should develops mathematics well by turning all these mathematical systems with artificial contradictions to a compatible system, i.e., out of the classical run in mathematics but return to their origins. For such an aim, geometry is more applicable, which is an encouraging thing for mathematicians in 21th century.

References

- [1] M.Carmeli, *Classical Fields–General Relativity and Gauge Theory*, World Scientific, 2001.
- [2] Fritz John. *Partial Differential Equations*(4th Edition). New York, USA: Springer-Verlag, 1982.
- [3] H.Iseri, *Smarandache Manifolds*, American Research Press, Rehoboth, NM,2002.
- [4] John M.Lee, *Introduction to Topological Manifolds*, Springer-Verlag New York, Inc., 2000.
- [5] F.Klein, A comparative review of recent researches in geometry, *Bull. New York Math. Soc.*, 2(1892-1893), 215-249.
- [6] Linfan Mao, Combinatorial speculation and combinatorial conjecture for mathematics, *International J.Math. Combin.* Vol.1(2007), No.1, 1-19.
- [7] Linfan Mao, Geometrical theory on combinatorial manifolds, *JP J.Geometry and Topology*, Vol.7, No.1(2007),65-114.
- [8] Linfan Mao, Combinatorial fields-an introduction, *International J. Math.Combin.*, Vol.1(2009), Vol.3, 1-22.
- [9] Linfan Mao, A combinatorial decomposition of Euclidean spaces \mathbb{R}^n with contribution to visibility, *International J. Math.Combin.*, Vol.1(2010), Vol.1, 47-64.
- [10] Linfan Mao, Relativity in combinatorial gravitational fields, *Progress in Physics*, Vol.3(2010), 39-50.
- [11] Linfan Mao, *Automorphism Groups of Maps, Surfaces and Smarandache Geometries*, First edition published by American Research Press in 2005, Second edition is as a Graduate

- Textbook in Mathematics, Published by The Education Publisher Inc., USA, 2011.
- [12] Linfan Mao, *Smarandache Multi-Space Theory*, First edition published by Hexis, Phoenix in 2006, Second edition is as a Graduate Textbook in Mathematics, Published by The Education Publisher Inc., USA, 2011.
 - [13] Linfan Mao, *Combinatorial Geometry with Applications to Field Theory*, First edition published by InfoQuest in 2005, Second edition is as a Graduate Textbook in Mathematics, Published by The Education Publisher Inc., USA, 2011.
 - [14] Linfan Mao, Graph structure of manifolds with listing, *International J.Contemp. Math. Sciences*, Vol.5, 2011, No.2,71-85.
 - [15] Linfan Mao, A generalization of Seifert-Van Kampen theorem for fundamental groups, *Far East Journal of Math.Sciences*, Vol.61 No.2 (2012), 141-160.
 - [16] Linfan Mao, Non-solvable spaces of linear equation systems, *International J. Math. Combin.*, Vol.2 (2012), 9-23.
 - [17] Linfan Mao, Global stability of non-solvable ordinary differential equations with applications, *International J.Math. Combin.*, Vol.1 (2013), 1-37.
 - [18] Linfan Mao, Non-solvable equation systems with graphs embedded in \mathbf{R}^n , *International J.Math. Combin.*, Vol.2 (2013), 8-23, Also in *Proceedings of the First International Conference on Smarandache Multispace and Multistructure*, The Education Publisher Inc. July, 2013
 - [19] Linfan Mao, Geometry on G^L -systems of homogenous polynomials, *International J.Contemp. Math. Sciences*, Vol.9 (2014), No.6, 287-308.
 - [20] Linfan Mao, A topological model for ecologically industrial systems, *International J.Math. Combin.*, Vol.1 (2014), 109-117.
 - [21] Linfan Mao, Cauchy problem on non-solvable system of first order partial differential equations with applications, *Methods and Applications of Analysis* (Accepted).
 - [22] Linfan Mao, Mathematics on non-mathematics - A combinatorial contribution, *International J.Math. Combin.*, Vol.3(2014), 1-34.
 - [23] F.Smarandache, *Paradoxist Geometry*, State Archives from Valcea, Rm. Valcea, Romania, 1969, and in *Paradoxist Mathematics*, Collected Papers (Vol. II), Kishinev University Press, Kishinev, 5-28, 1997.
 - [24] F.Smarandache, Multi-space and multi-structure, in *Neutrosophy. Neutrosophic Logic, Set, Probability and Statistics*, American Research Press, 1998.
 - [25] F.Smarandache, *A Unifying Field in Logics. Neutrosopy: Neturosophic Probability, Set, and Logic*, American research Press, Rehoboth, 1999.
 - [26] Wolfgang Walter, *Ordinary Differential Equations*, Springer-Verlag New York, Inc., 1998.

On Generalized Quasi-Kenmotsu Manifolds

Barnali Laha and Arindam Bhattacharyya

(Department of Mathematics, Jadavpur University, Kolkata-700032, India)

E-mail: barnali.laha87@gmail.com, bhattachar1968@yahoo.co.in

Abstract: We present a brief analysis on some properties of generalized quasi-Sasakian manifolds, discuss some important properties, particularly, regard the integrability conditions of this kind of manifolds in this paper.

Key Words: Riemannian manifold, semi-Riemannian manifold, quasi-Sasakian structure, integrability.

AMS(2010): 53C25

§1. Introduction

An interesting topic in the differential geometry is the theory of submanifolds in space endowed with additional structures ([5], [6]). Cr-submanifolds of Kaehler manifolds were studied by A.Bejancu, B.Y.Chen, N.Papaghiuc etc. have studied semi-invariant submanifolds in Sasakian manifolds ([1], [9]). The notion of Kenmotsu manifolds was defined by K.Kenmotsu in 1972 ([10]). N.Papaghiuc have studied semi-invariant submanifolds in a Kenmotsu manifold ([11]). He also studied the geometry of leaves on a semi-invariant ξ^\perp -submanifolds in a Kenmotsu manifolds ([12]).

§2. Preliminaries

Definition 2.1 An $(2n + 1)$ -dimensional semi-Riemannian manifold (\tilde{M}, \tilde{g}) is said to be an indefinite almost contact manifold if it admits an indefinite almost contact structure (ϕ, ξ, η) , where ϕ is a tensor field of type $(1, 1)$, ξ is a vector field and η is a 1-form, satisfying

$$\phi^2 X = -X + \eta(X)\xi, \quad \eta \circ \phi = 0, \quad \phi\xi = 0, \quad \eta(\xi) = 1, \quad (2.1)$$

$$\tilde{g}(\phi X, \phi Y) = \tilde{g}(X, Y) - \epsilon\eta(X)\eta(Y), \quad (2.2)$$

$$\tilde{g}(X, \xi) = \epsilon\eta(X), \quad (2.3)$$

¹The first author is supported by UGC-BSR fellowship, India.

²Received April 3, 2014, Accepted December 1, 2014.

$$\tilde{g}(\phi X, \phi Y) = \tilde{g}(X, Y) - \eta(X)\eta(Y) \quad (2.4)$$

for all vector fields X, Y on \tilde{M} and where $\epsilon = \tilde{g}(\xi, \xi) = \pm 1$ and $\tilde{\nabla}$ is the Levi-Civita (L-C) connection for a semi-Riemannian metric \tilde{g} . Let $F(\tilde{M})$ be the algebra of the smooth functions on \tilde{M} .

Definition 2.2 An almost contact manifold $\tilde{M}(\phi, \xi, \eta)$ is said to be normal if

$$N_\phi(X, Y) + 2d\eta(X, Y)\xi = 0$$

where

$$N_\phi(X, Y) = [\phi X, \phi Y] + \phi^2[X, Y] - \phi[\phi X, Y] - \phi[X, \phi Y] \quad X, Y \in \Gamma(T\tilde{M})$$

is the nijenhuis tensor field corresponding to the tensor fields ϕ . The fundamental 2-form Φ on \tilde{M} is defined by

$$\Phi(X, Y) = \tilde{g}(X, \phi Y).$$

In [7]-[8], the authors studied hypersurfaces of an almost contact metric manifold \tilde{M} . In this paper we define hypersurfaces of an almost contact metric manifold \tilde{M} whose structure tensor field satisfy the following relation

$$(\tilde{\nabla}_X \phi)Y = \tilde{g}(\tilde{\nabla}_{\phi^2 X} \xi, Y)\xi - \eta(Y)\tilde{\nabla}_{\phi^2 X} \xi, \quad (2.5)$$

where $\tilde{\nabla}$ is the Levi-Civita connection of the metric tensor \tilde{g} . We name this manifold \tilde{M} equipped with an almost contact metric structure satisfying from (2.5) as generalized Quasi-Kenmotsu manifold, in short G.Q.K.

We define a $(1, 1)$ tensor field F by

$$FX = \tilde{\nabla}_X \xi. \quad (2.6)$$

Let us now state the following proposition:

Proposition 2.1 If \tilde{M} is a G.Q.K manifold then any integral curve of the structure vector field ξ is a geodesic i.e. $\tilde{\nabla}_\xi \xi = 0$. Again $d\Phi = 0$ iff ξ is a Killing vector field.

Proof From equation (2.5) putting $X = Y = \xi$ we can easily prove this assertion.

Next, we derive

$$\begin{aligned} 3d\Phi(X, Y, Z) &= \tilde{g}((\tilde{\nabla}_X \phi)Z, Y) + \tilde{g}((\tilde{\nabla}_Z \phi)Y, X) + \tilde{g}((\tilde{\nabla}_Y \phi)X, Z) \\ &\quad + \eta(X)(\tilde{g}(Y, \tilde{\nabla}_{\phi Z} \xi) + \tilde{g}(\phi Z, \tilde{\nabla}_Y \xi)) \\ &\quad + \eta(Y)(\tilde{g}(Z, \tilde{\nabla}_{\phi X} \xi) + \tilde{g}(\phi X, \tilde{\nabla}_Z \xi)) \\ &\quad + \eta(Z)(\tilde{g}(X, \tilde{\nabla}_{\phi Y} \xi) + \tilde{g}(\phi Y, \tilde{\nabla}_X \xi)) = 0. \end{aligned}$$

Therefore, if ξ is a killing vector field then $d\Phi = 0$.

Conversely, Suppose $d\Phi = 0$. taking into account $X = \xi, \eta(Y) = \eta(Z) = 0$, the last equation implies

$$\tilde{g}(Y, \tilde{\nabla}_{\phi Z}\xi) + \tilde{g}(\phi Z, \tilde{\nabla}_Y\xi) = 0$$

Now substituting $Z = \phi Z$ and $Y = Y - \eta(Y)\xi$ we get,

$$\tilde{g}(Y - \eta(Y)\xi, \tilde{\nabla}_{\phi^2 Z}\xi) + \tilde{g}(\phi^2 Z, \tilde{\nabla}_{Y - \eta(Y)\xi}\xi) = 0$$

This implies ξ is a killing vector field. \square

Let \tilde{M} be a G.Q.K manifold and considering an m -dimensional submanifold M , isometrically immersed in \tilde{M} . Assuming g, ∇ , are the induced metric and levi-Civita connvection on M respectively. Let ∇^\perp and h be the normal connection induced by $\tilde{\nabla}$ on the normal bundle TM^\perp and the second fundamental form of M , respectively.

Therefore, we can decompose the tangent bundle as

$$T\tilde{M} = TM \oplus TM^\perp.$$

The Gauss and Weingarten formulae are characterized by the equations

$$\tilde{\nabla}_X Y = \nabla_X Y + h(X, Y), \quad (2.7)$$

$$\tilde{\nabla}_X N = -A_N X + \nabla_X^\perp N, \quad (2.8)$$

where A_N is the Weingarten map w.r.t the normal section N and satisfies

$$g(A_N X, Y) = g(h(X, Y), N) \quad X, Y \in \Gamma(TM), N \in \Gamma(TM^\perp). \quad (2.9)$$

Now we shall give the definition of semi-invariant ξ^\perp -submanifold. According to Bejancu ([4]) M is a semi-invariant ξ^\perp -submanifold if there exists two orthogonal distributions, D and D^\perp in TM such that

$$TM = D \oplus D^\perp, \phi D = D, \phi D^\perp \subset TM^\perp, \quad (2.10)$$

where \oplus denotes the orthogonal sum.

If $D^\perp = \{0\}$, then M is an invariant ξ^\perp -submanifold. The normal bundle can also be decomposed as

$$TM^\perp = \phi D^\perp \oplus \mu,$$

where $\phi\mu \subset \mu$. Hence μ contains ξ .

§3. Integrability of Distributions on a Semi-Invariant ξ^\perp -Submanifolds

Let M be a semi-invariant ξ^\perp -submanifold of a G.Q.K manifold \tilde{M} . We denote by P and Q the projections of TM on D and D^\perp respectively, namely for any $X \in \Gamma(TM)$.

$$X = PX + QX, \quad (3.1)$$

Again, for any $X \in \Gamma(TM)$ and $N \in \Gamma(TM^\perp)$ we put

$$\phi X = tX + \omega X, \quad (3.2)$$

$$\phi N = BN + CN, \quad (3.3)$$

with $tX \in \Gamma(D)$, $BN \in \Gamma(TM)$ and $\omega X, CN \in \Gamma(TM^\perp)$. Again, for $X \in \Gamma(TM)$, the decomposition is

$$FX = \alpha X + \beta X, \alpha X \in \Gamma(D), \beta X \in \Gamma(TM^\perp). \quad (3.4)$$

This section deals with the study of the integrability of both distributions D and D^\perp . We have the following proposition:

Proposition 3.1 *Let M be a semi-invariant ξ^\perp -submanifold of a G.Q.K manifold \tilde{M} . Then we obtain*

$$(\nabla_X t)Y = A_{\omega Y}X + Bh(X, Y) \quad (3.5a)$$

$$(\nabla_X \omega)Y = Ch(X, Y) - h(X, tY) - g(FX, Y)\xi. \quad (3.5b)$$

Proof Notice that

$$\begin{aligned} (\tilde{\nabla}_X \phi)YZ &= -\phi \tilde{\nabla}_X Y + \tilde{\nabla}_X \phi Y \\ &= -\phi(\nabla_X Y + h(X, Y)) + \tilde{\nabla}_X TY + \tilde{\nabla}_X tY + \tilde{\nabla}_X \omega Y. \end{aligned}$$

Using (3.3) and (3.4) and the Gauss and Weingarten formula we get

$$(\tilde{\nabla}_X \phi)Y = (-t\nabla_X Y + \nabla_X tY) + (-\omega\nabla_X Y + \nabla_X^\perp \omega Y) - Bh(X, Y) - Ch(X, Y) + h(X, tY) - A_{\omega Y}X.$$

After some brief calculations we deduce

$$(\tilde{\nabla}_X \phi)Y = (\nabla_X t)Y + (\nabla_X \omega)Y - Bh(X, Y) - Ch(X, Y) + h(X, tY) - A_{\omega Y}X.$$

Again,

$$(\tilde{\nabla}_X \phi)Y = \tilde{g}(\tilde{\nabla}_{\phi^2 X} \xi, Y)\xi - \eta(Y)\tilde{\nabla}_{\phi^2 X} \xi,$$

Using (2.1) and some steps of calculations, we obtain

$$(\tilde{\nabla}_X \phi)Y = -g(\tilde{\nabla}_X \xi, Y)\xi,$$

as $(\eta(Y) = 0, g(\xi, Y) = 0$ as $\xi \perp D, D^\perp$). Hence,

$$(\tilde{\nabla}_X \phi)Y = -g(FX, Y)\xi.$$

On comparing the tangential and normal components we shall obtain the results. \square

Taking into the consideration the decomposition of TM^\perp , we can prove that:

Proposition 3.2 *Let M be a semi-invariant ξ^\perp -submanifold of a G.Q.K manifold \tilde{M} . Then for any $N \in \Gamma(TM^\perp)$, there are*

- (1) $BN \in D^\perp$;
- (2) $CN \in \mu$.

Proof Let $N \in \Gamma(TM^\perp)$,

$$\phi N = BN + CN,$$

We know $TM^\perp = \phi D^\perp \oplus \mu$. Therefore we have

$$BN \in \phi D^\perp \subseteq D^\perp, CN \in \mu. \quad \square$$

Proposition 3.3 *Let M be a semi-invariant ξ^\perp -submanifold of a G.Q.K manifold \tilde{M} , then*

$$A_{\omega X}Y = A_{\omega Y}X,$$

for any $X, Y \in \Gamma(TM^\perp)$.

Proof From equation (2.9) we have

$$\begin{aligned} g(A_{\omega X}Y, Z) &= g(h(Y, Z), \omega X) = g(\tilde{\nabla}_Z Y, \omega X) \\ &= -g(\omega \tilde{\nabla}_Z Y, X) = g(\omega Y, h(Z, X)) \\ &= g(h(X, Z), \omega Y) = g(A_{\omega Y}X, Z). \end{aligned}$$

Hence the result. □

Proposition 3.4 *Let M be a semi-invariant ξ^\perp -submanifold of a G.Q.K manifold \tilde{M} . Then the distribution D^\perp is integrable.*

Proof Let $Z, X \in \Gamma(D^\perp)$. Then

$$\begin{aligned} \nabla_Z tX &= (\nabla_Z t)X + t\nabla_Z X \\ \nabla_Z tX &= A_{X\omega}Z + Bh(Z, X) + t\nabla_Z X. \end{aligned}$$

Therefore, (i)

$$t\nabla_Z X = \nabla_Z tX - A_{\omega X}Z - Bh(X, Z)$$

Interchanging X and Z we have (ii)

$$t\nabla_X Z = \nabla_X tZ - A_{\omega Z}X - Bh(Z, X).$$

Subtracting equation (ii) from (i) and using Proposition (3.3), we obtain

$$t([Z, X]) = \nabla_Z tX - \nabla_X tZ. \quad \square$$

Theorem 3.1 *If M is a semi-invariant ξ^\perp -submanifold of a G.Q.K manifold \tilde{M} , then the*

distribution D is integrable if and only if

$$h(Z, tW) - h(W, tZ) = (\mathbf{L}_\xi \tilde{g})(Z, W)\xi, \quad X, Y \in \Gamma(D).$$

Proof From the covariant derivative we have

$$\nabla_Z \omega W = (\tilde{\nabla}_Z \omega W) + \omega \nabla_Z W,$$

$$\nabla_Z \omega W = Ch(Z, W) - h(Z, tW) - g(FZ, W)\xi + \omega(\nabla_Z W + h(Z, W))$$

for $Z, W \in \Gamma(D)$. Again using Weingarten formulae we have

$$\nabla_Z \omega W = -A_{\omega W} Z + \nabla_Z^\perp \omega W.$$

Comparing both the equations we get

$$-A_{\omega W} Z + \nabla_Z^\perp \omega W = Ch(Z, W) - h(Z, tW) - g(FZ, W)\xi + \omega(\nabla_Z W + h(Z, W)).$$

On a simplification we obtain

$$\omega \nabla_W Z = \nabla_Z^\perp \omega W - A_{\omega W} Z - Ch(Z, W) + h(W, tZ) - g(FW, Z)\xi.$$

Interchanging W and Z in the above equation, we get

$$\omega \nabla_Z W = \nabla_W^\perp \omega Z - A_{\omega Z} W - Ch(W, Z) + h(Z, tW) - g(FZ, W)\xi.$$

Subtracting the above two equations and using Proposition 3.3 we get

$$\omega[Z, W] = h(Z, tW) - h(W, tZ) - g(FZ, W)\xi + g(FW, Z)\xi.$$

We also know that

$$(\mathbf{L}_\xi \tilde{g})(Z, W)\xi = g(FZ, W)\xi - g(FW, Z)\xi.$$

Therefore the distribution D is integrable if

$$h(Z, tW) - h(W, tZ) = (\mathbf{L}_\xi \tilde{g})(Z, W)\xi. \quad \square$$

Proposition 3.5 *Let M be a semi-invariant ξ^\perp -submanifold of a $G.Q.K$ manifold \tilde{M} . Then $\alpha X = A_\xi X$ and $\beta X = -\nabla_X^\perp \xi$ $X \in \Gamma(TM)$.*

Proof From Weingarten formulae we get

$$\tilde{\nabla}_X \xi = -A_\xi X + \nabla_X^\perp \xi.$$

Again we know from (3.4),

$$\tilde{\nabla}_X \xi = -FX = -\alpha X - \beta X.$$

Comparing these formulae we get $\alpha X = A_\xi X$ and $\beta X = -\nabla_X^\perp \xi$ by assuming

$$\{e_i, \phi e_i, e_{2p+j}\}, i = \{1, \dots, p\}, j = \{1, \dots, q\}$$

being an adapted orthonormal local frame on M , where $q = \dim D^\perp$ and $2p = \dim D$. □

Similarly, the following theorem is obtained.

Theorem 3.2 *If M is a ξ^\perp -semiinvariant submanifold of a G.Q.K manifold \tilde{M} one has*

$$\eta(H) = \frac{1}{m} \text{trace} (A_\xi); m = 2p + q.$$

Proof From the mean curvature formula

$$H = \frac{1}{m} \sum_{a=1}^s \text{trace}(A_{\xi_a}) \xi_a,$$

where $\{\xi_1, \dots, \xi_s\}$ is an orthonormal basis in TM^\perp ,

$$\eta(H) = \frac{1}{m} \sum_{a=1}^s \text{trace}(A_{\xi_a}) \cdot 1,$$

$$\eta(H) = \frac{1}{m} \text{trace}(A_\xi). \quad \square$$

Corollary 3.1 *If the leaves of the integrable distribution D are totally geodesic in M then the structures vector field ξ is D -killing, i.e. $(\mathbf{L}_\xi g)(X, Y) = 0, X, Y \in \Gamma(D)$.*

Proof We know that

$$\begin{aligned} (\mathbf{L}_\xi g)(X, Y) &= g(\nabla_X \xi, Y) + g(X, \nabla_Y \xi) \\ &= g(\nabla_X Y, \xi) + g(\xi, \nabla_Y X) = 0, \quad X, Y \in \Gamma(D). \end{aligned}$$

Acknowledgement The first author has been sponsored by UGC-BSR fellowship, India.

References

- [1] A.Bejancu, CR-submanifolds of a Kaehlerian manifold I, *Proc. of the Amer. Math. Society*, 69(1978), 135-142.
- [2] A.Bejancu, CR-submanifolds of a Kaehlerian manifold II, *Transactions of the Amer. Math. Society*, 250(1979), 333-345.
- [3] A.Bejancu and N.Papaghiuc, Semi invariant submanifolds of a Sasakain manifold, *Al. I. Cuza, Iasi, Sect I a Math.*, **27**(1)(1981), 163-170.
- [4] A.Bejancu, Geometry of CR-submanifolds, *Mathematics and its Applications*, D.Reidel Publishing Co., Dordrecht, 1986.

- [5] B.Y.Chen, Riemannian submanifolds, in *Handbook of differential geometry*, Vol.1, eds. F.Dillen and L. Verstraelen, North-Holland, Amsterdam, 2000, pp.187-418.
- [6] B.Y.Chen, S-invariants inequalities of submanifolds and their applications, in : *Topics in differential geometry*, Ed. Acad. Romane. Bucharest, 2008, pp. 29-155.
- [7] S.S.Eum, On Kählerian hypersurfaces in almost contact metric spaces, *Tensor*, 20(1969), 37-44.
- [8] S.S.Eum, A Kählerian hypersurfaces with parallel Ricci tensor in an almost contact metric spaces of constant C-holomorphic sectional curvature, *Tensor*, 21(1970), 315-318.
- [9] M.I.Munteanu, Warped product contact CR-submanifolds of Sasakian space forms, *Publ. Math. Debrecen*, **66**(1-2)(2005), 75-120.
- [10] K.Kenmotsu, A class of almost contact Riemannian manifolds, *Tohoku Math.J.*, (2), **24**(1972), 93-103.
- [11] N.Papaghiuc, Semi-invariant submanifolds in a Kenmotsu manifolds, *Rend.Mat.*, (7), **3**(4)(1983), 607-622.
- [12] N.Papaghiuc, On the geometry of leaves on a semi-invariant ξ^\perp -submanifold in a Kenmotsu manifold, *An.Stiint.Univ, Al.I.Cuza Iasi Sect. I a Mat.*, **38**(1)(1992), 111-119.

On Super (a, d) -Edge-Antimagic Total Labeling of a Class of Trees

A.Raheem, A.Q.Baig

Department of Mathematics, COMSATS Institute of Information Technology
Attock, Pakistan

M.Javaid

Department of Mathematics, School of Science and Technology
University of Management and Technology (UMT), Lahore, Pakistan

E-mail: rahimciit7@gmail.com, aqbaig1@gmail.com, muhammad.javaid@umt.edu.pk

Abstract: The concept of labeling has its origin in the works of Stewart (1966), Kotzig and Rosa (1970). Later on Enomoto, Llado, Nakamigawa and Ringel (1998) defined a super $(a, 0)$ -edge-antimagic total labeling and proposed the conjecture that every tree is a super $(a, 0)$ -edge-antimagic total graph. In the favour of this conjecture, the present paper deals with different results on antimagicness of a class of trees, which is called subdivided stars.

Key Words: Smarandachely super (a, d) -edge-antimagic total labeling, super (a, d) -edge-antimagic total labeling, stars and subdivision of stars.

AMS(2010): 53C78

§1. Introduction

All graphs in this paper are finite, undirected and simple. For a graph G , $V(G)$ and $E(G)$ denote the vertex-set and the edge-set, respectively. A (v, e) -graph G is a graph such that $|V(G)| = v$ and $|E(G)| = e$. A general reference for graph-theoretic ideas can be seen in [28]. A *labeling* (or *valuation*) of a graph is a map that carries graph elements to numbers (usually to positive or non-negative integers). In this paper, the domain will be the set of all vertices and edges and such a labeling is called a *total labeling*. Some labelings use the vertex-set only or the edge-set only and we shall call them *vertex-labelings* or *edge-labelings*, respectively.

Definition 1.1 An (s, d) -edge-antimagic vertex (abbreviated to (s, d) -EAV) labeling of a (v, e) -graph G is a bijective function $\lambda : V(G) \rightarrow \{1, 2, \dots, v\}$ such that the set of edge-sums of all edges in G , $\{w(xy) = \lambda(x) + \lambda(y) : xy \in E(G)\}$, forms an arithmetic progression $\{s, s + d, s + 2d, \dots, s + (e - 1)d\}$, where $s > 0$ and $d \geq 0$ are two fixed integers.

Furthermore, let $H \leq G$. If there is a bijective function $\lambda : V(H) \rightarrow \{1, 2, \dots, |H|\}$

¹Received October 23, 2013, Accepted December 2, 2014.

such that the set of edge-sums of all edges in H forms an arithmetic progression $\{s, s + d, s + 2d, \dots, s + (|E(H)| - 1)d\}$ but for all edges not in H is a constant, such a labeling is called a Smarandachely (s, d) -edge-antimagic labeling of G respect to H . Clearly, an (s, d) -EAV labeling of G is a Smarandachely (s, d) -EAV labeling of G respect to G itself.

Definition 1.2 A bijection $\lambda : V(G) \cup E(G) \rightarrow \{1, 2, \dots, v+e\}$ is called an (a, d) -edge-antimagic total $((a, d)$ -EAT) labeling of a (v, e) -graph G if the set of edge-weights $\{\lambda(x) + \lambda(xy) + \lambda(y) : xy \in E(G)\}$ forms an arithmetic progression starting from a and having common difference d , where $a > 0$ and $d \geq 0$ are two chosen integers. A graph that admits an (a, d) -EAT labeling is called an (a, d) -EAT graph.

Definition 1.3 If λ is an (a, d) -EAT labeling such that $\lambda(V(G)) = \{1, 2, \dots, v\}$ then λ is called a super (a, d) -EAT labeling and G is known as a super (a, d) -EAT graph.

In Definitions 1.2 and 1.3, if $d = 0$ then an $(a, 0)$ -EAT labeling is called an edge-magic total (EMT) labeling and a super $(a, 0)$ -EAT labeling is called a super edge magic total (SEMT) labeling. Moreover, in general a is called minimum edge-weight but particularly magic constant when $d = 0$. The definition of an (a, d) -EAT labeling was introduced by Simanjuntak, Bertault and Miller in [23] as a natural extension of *magic valuation* defined by Kotzig and Rosa [17-18]. A super (a, d) -EAT labeling is a natural extension of the notion of *super edge-magic labeling* defined by Enomoto, Llado, Nakamigawa and Ringel. Moreover, Enomoto et al. [8] proposed the following conjecture.

Conjecture 1.1 Every tree admits a super $(a, 0)$ -EAT labeling.

In the favor of this conjecture, many authors have considered a super $(a, 0)$ -EAT labeling for different particular classes of trees. Lee and Shah [19] verified this conjecture by a computer search for trees with at most 17 vertices. For different values of d , the results related to a super (a, d) -EAT labeling can be found for w-trees [13], stars [20], subdivided stars [14, 15, 21, 22, 29, 30], path-like trees [3], caterpillars [17, 18, 25], disjoint union of stars and books [10] and wheels, fans and friendship graphs [24], paths and cycles [23] and complete bipartite graphs [1]. For detail studies of a super (a, d) -EAT labeling reader can see [2, 4, 5, 7, 9-12].

Definition 1.4 Let $n_i \geq 1$, $1 \leq i \leq r$, and $r \geq 2$. A subdivided star $T(n_1, n_2, \dots, n_r)$ is a tree obtained by inserting $n_i - 1$ vertices to each of the i th edge of the star $K_{1,r}$. Moreover suppose that $V(G) = \{c\} \cup \{x_i^{l_i} | 1 \leq i \leq r; 1 \leq l_i \leq n_i\}$ is the vertex-set and $E(G) = \{cx_i^1 | 1 \leq i \leq r\} \cup \{x_i^{l_i} x_i^{l_i+1} | 1 \leq i \leq r; 1 \leq l_i \leq n_i - 1\}$ is the edge-set of the subdivided star $G \cong T(n_1, n_2, \dots, n_r)$ then $v = \sum_{i=1}^r n_i + 1$ and $e = \sum_{i=1}^r n_i$.

Lu [29,30] called the subdivided star $T(n_1, n_2, n_3)$ as a three-path tree and proved that it is a super $(a, 0)$ -EAT graph if n_1 and n_2 are odd with $n_3 = n_2 + 1$ or $n_3 = n_2 + 2$. Ngurah et al. [21] proved that the subdivided star $T(n_1, n_2, n_3)$ is also a super $(a, 0)$ -EAT graph if $n_3 = n_2 + 3$ or $n_3 = n_2 + 4$. Salman et al. [22] found a super $(a, 0)$ -EAT labeling on the subdivided stars $T(\underbrace{n, n, n, \dots, n}_{r\text{-times}})$, where $n \in \{2, 3\}$.

Moreover, Javaid et al. [14,15] proved the following results related to a super (a, d) -EAT labeling on different subclasses of subdivided stars for different values of d :

- For any odd $n \geq 3$, $G \cong T(n, n-1, n, n)$ admits a super $(a, 0)$ -EAT labeling with $a = 10n + 2$;
- For any odd $n \geq 3$ and $m \geq 3$, $G \cong T(n, n, m, m)$ admits a super $(a, 0)$ -EAT labeling with $a = 6n + 5m + 2$;
- For any odd $n \geq 3$ and $p \geq 5$, $G \cong T(n, n, n+2, n+2, n_5, \dots, n_p)$ admits a super $(a, 0)$ -EAT labeling with $a = 2v + s - 1$, a super $(a, 1)$ -EAT labeling with $a = s + \frac{3}{2}v$ and a super $(a, 2)$ -EAT labeling with $a = v + s + 1$ where $v = |V(G)|$, $s = (2n + 6) + \sum_{m=5}^p [(n+1)2^{m-5} + 1]$ and $n_r = 1 + (n+1)2^{r-4}$ for $5 \leq r \leq p$.

However, the investigation of the different results related to a super (a, d) -EAT labeling of the subdivided star $T(n_1, n_2, n_3, \dots, n_r)$ for $n_1 \neq n_2 \neq n_3, \dots, \neq n_r$ is still open. In this paper, for $d \in \{0, 1, 2\}$, we formulate a super (a, d) -EAT labeling on the subclasses of subdivided stars denoted by $T(kn, kn, kn, kn, 2kn, n_6, \dots, n_r)$ and $T(kn, kn, 2n, 2n+2, n_5, \dots, n_r)$ under certain conditions.

§2. Basic Results

In this section, we present some basic results which will be used frequently in the main results. Ngurah et al. [21] found lower and upper bounds of the minimum edge-weight a for a subclass of the subdivided stars, which is stated as follows:

Lemma 2.1 *If $T(n_1, n_2, n_3)$ is a super $(a, 0)$ -EAT graph, then $\frac{1}{2l}(5l^2 + 3l + 6) \leq a \leq \frac{1}{2l}(5l^2 + 11l - 6)$, where $l = \sum_{i=1}^3 n_i$.*

The lower and upper bounds of the minimum edge-weight a for another subclass of subdivided stars established by Salman et al. [22] are given below:

Lemma 2.2 *If $T(\underbrace{n, n, \dots, n}_{n\text{-times}})$ is a super $(a, 0)$ -EAT graph, then $\frac{1}{2l}(5l^2 + (9 - 2n)l + n^2 - n) \leq a \leq \frac{1}{2l}(5l^2 + (2n + 5)l + n - n^2)$, where $l = n^2$.*

Moreover, the following lemma presents the lower and upper bound of the minimum edge-weight a for the most generalized subclass of subdivided stars proved by Javaid and Akhlaq:

Lemma 2.3([16]) *If $T(n_1, n_2, n_3, \dots, n_r)$ has a super (a, d) -EAT labeling, then $\frac{1}{2l}(5l^2 + r^2 - 2lr + 9l - r - (l-1)ld) \leq a \leq \frac{1}{2l}(5l^2 - r^2 + 2lr + 5l + r - (l-1)ld)$, where $l = \sum_{i=1}^r n_i$ and $d \in \{0, 1, 2, 3\}$.*

Bača and Miller [4] state a necessary condition for a graph to be super (a, d) -EAT, which

provides an upper bound on the parameter d . Let a (v, e) -graph G be a super (a, d) -EAT. The minimum possible edge-weight is at least $v + 4$. The maximum possible edge-weight is no more than $3v + e - 1$. Thus $a + (e - 1)d \leq 3v + e - 1$ or $d \leq \frac{2v + e - 5}{e - 1}$. For any subdivided star, where $v = e + 1$, it follows that $d \leq 3$.

Let us consider the following proposition which we will use frequently in the main results.

Proposition 2.1([3]) *If a (v, e) -graph G has a (s, d) -EAV labeling then*

- (1) G has a super $(s + v + 1, d + 1)$ -EAT labeling;
- (2) G has a super $(s + v + e, d - 1)$ -EAT labeling.

§3. Super (a, d) -EAT Labeling of Subdivided Stars

Theorem 3.1 *For any even $n \geq 2$ and $r \geq 6$, $G \cong T(n + 3, n + 2, n, n + 1, 2n + 1, n_6, \dots, n_r)$ admits a super $(a, 0)$ -edge-antimagic total labeling with $a = 2v + s - 1$ and a super $(a, 2)$ -edge-antimagic total labeling with $a = v + s + 1$ where $v = |V(G)|$, $s = (3n + 7) + \sum_{m=6}^r [2^{m-5}n + 1]$ and $n_m = 2^{m-4}n + 1$ for $6 \leq m \leq r$.*

Proof Let us denote the vertices and edges of G , as follows:

$$V(G) = \{c\} \cup \{x_i^{l_i} | 1 \leq i \leq r; 1 \leq l_i \leq n_i\},$$

$$E(G) = \{cx_i^1 | 1 \leq i \leq r\} \cup \{x_i^{l_i}x_i^{l_i+1} | 1 \leq i \leq r; 1 \leq l_i \leq n_i - 1\}.$$

If $v = |V(G)|$ and $e = |E(G)|$, then

$$v = (6n + 8) + \sum_{m=6}^r [2^{m-6}4n + 1] \quad \text{and} \quad e = v - 1.$$

Now, we define the labeling $\lambda : V(G) \rightarrow \{1, 2, \dots, v\}$ as follows:

$$\lambda(c) = (4n + 8) + \sum_{m=6}^r [2^{m-6}2n + 1].$$

For odd $1 \leq l_i \leq n_i$, where $i = 1, 2, 3, 4, 5$ and $6 \leq i \leq r$, we define

$$\lambda(u) = \begin{cases} \frac{l_1 + 1}{2}, & \text{for } u = x_1^{l_1}, \\ n + 3 - \frac{l_2 - 1}{2}, & \text{for } u = x_2^{l_2}, \\ (n + 4) + \frac{l_3 - 1}{2}, & \text{for } u = x_3^{l_3}, \\ (2n + 4) - \frac{l_4 - 1}{2}, & \text{for } u = x_4^{l_4}, \\ (3n + 5) - \frac{l_5 - 1}{2}, & \text{for } u = x_5^{l_5}. \end{cases}$$

and

$$\lambda(x_i^{l_i}) = (3n + 5) + \sum_{m=6}^i [2^{m-6}2n + 1] - \frac{l_i - 1}{2},$$

respectively. For even $1 \leq l_i \leq n_i$, $\alpha = (3n + 5) + \sum_{m=6}^r [2^{m-6}2n + 1]$, $i = 1, 2, 3, 4, 5$ and $6 \leq i \leq r$, we define

$$\lambda(u) = \begin{cases} (\alpha + 1) + \frac{l_1 - 2}{2}, & \text{for } u = x_1^{l_1}, \\ (\alpha + n + 2) - \frac{l_2 - 2}{2}, & \text{for } u = x_2^{l_2}, \\ (\alpha + n + 4) + \frac{l_3 - 2}{2}, & \text{for } u = x_3^{l_3}, \\ (\alpha + 2n + 3) - \frac{l_4 - 2}{2}, & \text{for } u = x_4^{l_4}, \\ (\alpha + 3n + 3) - \frac{l_5 - 2}{2}, & \text{for } u = x_5^{l_5} \end{cases}$$

and

$$\lambda(x_i^{l_i}) = (\alpha + 3n + 3) + \sum_{m=6}^i [2^{m-6}2n] - \frac{l_i - 2}{2},$$

respectively.

The set of all edge-sums generated by the above formula forms a consecutive integer sequence $s = \alpha + 2, \alpha + 3, \dots, \alpha + 1 + e$. Therefore, by Proposition 2.1, λ can be extended to a super $(a, 0)$ -edge-antimagic total labeling and we obtain the magic constant $a = v + e + s = 2v + (3n + 6) + \sum_{m=6}^r [2^{m-6}2n + 1]$.

Similarly by Proposition 2.2, λ can be extended to a super $(a, 2)$ -edge-antimagic total labeling and we obtain the magic constant $a = v + 1 + s = v + (3n + 8) + \sum_{m=6}^r [2^{m-6}2n + 1]$. \square

Theorem 3.2 For any odd $n \geq 3$ and $r \geq 6$, $G \cong T(n + 3, n + 2, n, n + 1, 2n + 1, n_6, \dots, n_r)$ admits a super $(a, 1)$ -edge-antimagic total labeling with $a = s + \frac{3v}{2}$ if v is even, where $v = |V(G)|$, $s = (3n + 7) + \sum_{m=6}^r [2^{m-5}n + 1]$ and $n_m = 2^{m-4}n + 1$ for $6 \leq m \leq r$.

Proof Let us consider the vertices and edges of G , as defined in Theorem 3.1. Now, we define the labeling $\lambda : V(G) \rightarrow \{1, 2, \dots, v\}$ as in same theorem. It follows that the edge-weights of all edges of G constitute an arithmetic sequence $s = \alpha + 2, \alpha + 3, \dots, \alpha + 1 + e$ with common difference 1, where

$$\alpha = (3n + 5) + \sum_{m=6}^r [2^{m-6}2n + 1].$$

We denote it by $A = \{a_i; 1 \leq i \leq e\}$. Now for G we complete the edge labeling λ for super $(a, 1)$ -edge-antimagic total labeling with values in the arithmetic sequence $v + 1, v + 2, \dots, v + e$ with common difference 1. Let us denote it by $B = \{b_j; 1 \leq j \leq e\}$. Define $C = \{a_{2i-1} + b_{e-i+1}; 1 \leq i \leq \frac{e+1}{2}\} \cup \{a_{2j} + b_{\frac{e-1}{2}-j+1}; 1 \leq j \leq \frac{e+1}{2} - 1\}$. It is easy to see

that C constitutes an arithmetic sequence with $d = 1$ and

$$a = s + \frac{3v}{2} = (12n + 19) + \frac{1}{2} \sum_{m=6}^r [2^{m-3}2n + 5].$$

Since all vertices receive the smallest labels, λ is a super $(a, 1)$ -edge-antimagic total labeling. \square

Theorem 3.3 For any even $n \geq 2$ and $r \geq 6$, $G \cong T(n + 2, n, n, n + 1, 2(n + 1), n_6, \dots, n_r)$ admits a super $(a, 0)$ -edge-antimagic total labeling with $a = 2v + s - 1$ and a super $(a, 2)$ -edge-antimagic total labeling with $a = v + s + 1$ where $v = |V(G)|$, $s = (3n + 5) + \sum_{m=6}^r [2^{m-5}n + 2]$ and $n_m = 2^{m-4}n + 2$ for $6 \leq m \leq r$.

Proof Let us denote the vertices and edges of G as follows:

$$V(G) = \{c\} \cup \{x_i^{l_i} | 1 \leq i \leq r; 1 \leq l_i \leq n_i\};$$

$$E(G) = \{cx_i^1 | 1 \leq i \leq r\} \cup \{x_i^{l_i}x_i^{l_i+1} | 1 \leq i \leq r; 1 \leq l_i \leq n_i - 1\}.$$

If $v = |V(G)|$ and $e = |E(G)|$, then

$$v = (6n + 6) + \sum_{m=6}^r [2^{m-6}4(n+)] \quad \text{and} \quad e = v - 1.$$

Now, we define the labeling $\lambda : V(G) \rightarrow \{1, 2, \dots, v\}$ as follows:

$$\lambda(c) = (4n + 5) + \sum_{m=6}^r [2^{m-6}2n + 2].$$

For odd $1 \leq l_i \leq n_i$, where $i = 1, 2, 3, 4, 5$ and $6 \leq i \leq r$, we define

$$\lambda(u) = \begin{cases} \frac{l_1 + 1}{2}, & \text{for } u = x_1^{l_1}, \\ n + 1 - \frac{l_2 - 1}{2}, & \text{for } u = x_2^{l_2}, \\ (n + 2) - \frac{l_3 + 1}{2}, & \text{for } u = x_3^{l_3}, \\ (2n + 2) - \frac{l_4 - 1}{2}, & \text{for } u = x_4^{l_4}, \\ (3n + 3) - \frac{l_5 - 1}{2}, & \text{for } u = x_5^{l_5}. \end{cases}$$

$$\lambda(x_i^{l_i}) = (3n + 3) + \sum_{m=6}^i [2^{m-6}2n + 2] - \frac{l_i - 1}{2},$$

respectively. For even $1 \leq l_i \leq n_i$, $\alpha = (3n + 43) + \sum_{m=6}^r [2^{m-6}2n + 2]$, $i = 1, 2, 3, 4, 5$ and

$5 \leq i \leq r$, we define

$$\lambda(u) = \begin{cases} (\alpha + 1) + \frac{l_1 - 2}{2}, & \text{for } u = x_1^{l_1}, \\ (\alpha + n(\alpha + n + 1) - \frac{l_2 - 2}{2}), & \text{for } u = x_2^{l_2}, \\ (\alpha + n + 3) - \frac{l_3 - 2}{2}, & \text{for } u = x_3^{l_3}, \\ (\alpha + 2n + 2) - \frac{l_4 - 2}{2}, & \text{for } u = x_4^{l_4}, \\ (\alpha + 3n + 3) - \frac{l_5 - 2}{2}, & \text{for } u = x_5^{l_5} \end{cases}$$

and

$$\lambda(x_i^{l_i}) = (\alpha + 3n + 3) + \sum_{m=6}^i [2^{m-6}4(n+1)] - \frac{l_i - 2}{2},$$

respectively.

The set of all edge-sums generated by the above formula forms a consecutive integer sequence $s = \alpha + 2, \alpha + 3, \dots, \alpha + 1 + e$. Therefore, by Proposition 2.1, λ can be extended to a super $(a, 0)$ -edge-antimagic total labeling and we obtain the magic constant

$$a = v + e + s = 2v + (3n + 4) + \sum_{m=6}^r [2^{m-6}2n + 2].$$

Similarly by Proposition 2.2, λ can be extended to a super $(a, 2)$ -edge-antimagic total labeling and we obtain the magic constant $a = v + 1 + s = v + (3n + 6) + \sum_{m=6}^r [2^{m-6}2n + 2]$. \square

Theorem 3.4 *For any odd $n \geq 3$ and $r \geq 6$, $G \cong T(n + 2, n, n, n + 1, 2(n + 1), n_6, \dots, n_r)$ admits a super $(a, 1)$ -edge-antimagic total labeling with $a = s + \frac{3v}{2}$ if v is even, where $v = |V(G)|$, $s = (3n + 5) + \sum_{m=6}^r [2^{m-5}n + 2]$ and $n_m = 2^{m-4}n + 2$ for $6 \leq m \leq r$.*

Proof Let us consider the vertices and edges of G , as defined in Theorem 3.3. Now, we define the labeling $\lambda : V(G) \rightarrow \{1, 2, \dots, v\}$ as in same theorem. It follows that the edge-weights of all edges of G constitute an arithmetic sequence $s = \alpha + 2, \alpha + 3, \dots, \alpha + 1 + e$ with common difference 1, where

$$\alpha = (3n + 3) + \sum_{m=6}^r [2^{m-6}2(n + 1)].$$

We denote it by $A = \{a_i; 1 \leq i \leq e\}$. Now for G we complete the edge labeling λ for super $(a, 1)$ -edge-antimagic total labeling with values in the arithmetic sequence $v + 1, v + 2, \dots, v + e$ with common difference 1. Let us denote it by $B = \{b_j; 1 \leq j \leq e\}$. Define $C = \{a_{2i-1} + b_{e-i+1}; 1 \leq i \leq \frac{e+1}{2}\} \cup \{a_{2j} + b_{\frac{e-1}{2}-j+1}; 1 \leq j \leq \frac{e+1}{2} - 1\}$. It is easy to see

that C constitutes an arithmetic sequence with $d = 1$ and

$$a = s + \frac{3v}{2} = (12n + 14) + \sum_{m=6}^r [2^{m-5}(4n + 3) + 2].$$

Since all vertices receive the smallest labels, λ is a super $(a, 1)$ -edge-antimagic total labeling. \square

§4. Conclusion

In this paper, we have shown that two different subclasses of subdivided stars admit a super (a, d) -EAT labeling for $d \in \{0, 1, 2\}$. However, the problem is still open for the magicness of $T(n_1, n_2, n_3, \dots, n_r)$, where $n_i = n$ and $1 \leq i \leq r$.

Acknowledgement

The authors are indebted to the referee and the editor-in-chief, Dr.Linfan Mao for their valuable comments to improve the original version of this paper.

References

- [1] Bača M., Y.Lin, M.Miller and M.Z.Youssef, Edge-antimagic graphs, *Discrete Math.*, 307(2007), 1232–1244.
- [2] Bača M., Y.Lin, M.Miller and R.Simanjuntak, New constructions of magic and antimagic graph labelings, *Utilitas Math.*, 60(2001), 229–239.
- [3] Bača M., Y.Lin and F.A.Muntaner-Batle, Super edge-antimagic labelings of the path-like trees, *Utilitas Math.*, 73(2007), 117–128.
- [4] Bača M. and M. Miller, *Super Edge-Antimagic Graphs*, Brown Walker Press, Boca Raton, Florida USA, 2008.
- [5] Bača M., A.Semaničová -Feňovčíková and M.K.Shafiq, A method to generate large classes of edge-antimagic trees, *Utilitas Math.*, 86(2011), 33–43.
- [6] Baskoro E.T., I.W.Sudarsana and Y.M.Cholily, How to construct new super edge-magic graphs from some old ones, *J. Indones. Math. Soc. (MIHIM)*, **11:2** (2005), 155–162.
- [7] Dafik, M.Miller, J.Ryan and M.Bača, On super (a, d) -edge antimagic total labeling of disconnected graphs, *Discrete Math.*, 309 (2009), 4909–4915.
- [8] Enomoto H., A.S.Lladó, T.Nakamigawa and G.Ringel, Super edge-magic graphs, *SUT J. Math.*, 34 (1998), 105–109.
- [9] Figueroa-Centeno R.M., R.Ichishima and F.A.Muntaner-Batle, The place of super edge-magic labelings among other classes of labelings, *Discrete Math.*, 231 (2001), 153–168.
- [10] Figueroa-Centeno R.M., R.Ichishima and F.A. Muntaner-Batle, On super edge-magic graph, *Ars Combinatoria*, 64 (2002), 81–95.
- [11] Fukuchi Y., A recursive theorem for super edge-magic labeling of trees, *SUT J. Math.*, 36 (2000), 279–285.

- [12] Gallian J.A., A dynamic survey of graph labeling, *Electron. J. Combin.*, **17** (2010).
- [13] Javaid M., M.Hussain, K.Ali and K.H.Dar, Super edge-magic total labeling on w-trees, *Utilitas Math.*, 86 (2011), 183–191.
- [14] Javaid M., M.Hussain, K.Ali and H.Shaker, On super edge-magic total labeling on subdivision of trees, *Utilitas Math.*, 89 (2012), 169–177.
- [15] Javaid M. and A.A.Bhatti, On super (a, d) -edge-antimagic total labeling of subdivided stars, *Utilitas Math.*, 105 (2012), 503–512.
- [16] Javaid M. and A.A.Bhatti, Super (a, d) -edge-antimagic total labeling of subdivided stars and w-trees, *Utilitas Math.*, to appear.
- [17] Kotzig A. and A.Rosa, Magic valuations of finite graphs, *Canad. Math. Bull.*, 13 (1970), 451–461.
- [18] Kotzig A. and A.Rosa, Magic valuation of complete graphs, *Centre de Recherches Mathematiques, Universite de Montreal*, (1972), CRM-175.
- [19] Lee S.M. and Q.X.Shah, All trees with at most 17 vertices are super edge-magic, *16th MCCCC Conference, Carbondale*, University Southern Illinois, November (2002).
- [20] Lee S.M. and M.C.Kong, On super edge-magic n stars, *J. Combin. Math. Combin. Comput.*, 42 (2002), 81–96.
- [21] Ngurah A.A.G., R.Simanjuntak and E.T.Baskoro, On (super) edge-magic total labeling of subdivision of $K_{1,3}$, *SUT J. Math.*, 43 (2007), 127–136.
- [22] Salman A.N.M., A.A.G.Ngurah and N.Izzati, On super edge-magic total labeling of a subdivision of a star S_n , *Utilitas Mthematica*, 81 (2010), 275–284.
- [23] Simanjuntak R., F.Bertault and M.Miller, Two new (a, d) -antimagic graph labelings, *Proc. of Eleventh Australasian Workshop on Combinatorial Algorithms*, 11 (2000), 179–189.
- [24] Slamini, M. Bača, Y.Lin, M.Miller and R.Simanjuntak, Edge-magic total labelings of wheel, fans and friendship graphs, *Bull. ICA*, 35 (2002), 89–98.
- [25] Sugeng K.A., M.Miller, Slamini and M.Bača, (a, d) -edge-antimagic total labelings of caterpillars, *Lecture Notes Comput. Sci.*, 3330 (2005), 169–180.
- [26] Stewart M.B., Supermagic complete graphs, *Can. J. Math.*, 19 (1966): 427-438.
- [27] Wallis W.D., *Magic Graphs*, Birkhauser, Boston-Basel-Berlin, 2001.
- [28] West D. B., *An Introduction to Graph Theory*, Prentice-Hall, 1996.
- [29] Yong-Ji Lu, A proof of three-path trees $P(m, n, t)$ being edge-magic, *College Mathematica*, **17:2** (2001), 41–44.
- [30] Yong-Ji Lu, A proof of three-path trees $P(m, n, t)$ being edge-magic (II), *College Mathematica*, **20:3** (2004), 51–53.

Total Mean Cordial Labeling of Graphs

R.Ponraj, S.Sathish Narayanan

(Department of Mathematics, Sri Paramakalyani College, Alwarkurichi-627412, India)

A.M.S.Ramasamy

(Department of Mathematics, Vel Tech Dr.R.R & Dr.S.R Technical University, Chennai-600002, India)

E-mail: ponrajmaths@gmail.com, sathishrvss@gmail.com, ramasamyams@veltechuniv.edu.in

Abstract: In this paper, we introduce a new type of graph labeling known as total mean cordial labeling. A total mean cordial labeling of a graph $G = (V, E)$ is a mapping $f : V(G) \rightarrow \{0, 1, 2\}$ such that $f(xy) = \left\lfloor \frac{f(x) + f(y)}{2} \right\rfloor$ where $x, y \in V(G)$, $xy \in E$, and the total number of 0, 1 and 2 are balanced. That is $|ev_f(i) - ev_f(j)| \leq 1$, $i, j \in \{0, 1, 2\}$ where $ev_f(x)$ denotes the total number of vertices and edges labeled with x ($x = 0, 1, 2$). If there exists a total mean cordial labeling on a graph G , we will call G is Total Mean Cordial. In this paper, we study some classes of graphs and their Total Mean Cordial behaviour.

Key Words: Smarandachely total mean cordial labeling, total mean cordial labeling, path, cycle, wheel, complete graph, complete bipartite graph.

AMS(2010): 53C78

§1. Introduction

Unless mentioned otherwise, a graph in this paper shall mean a simple finite and undirected. For all terminology and notations in graph theory, we follow Harary [3]. The vertex and edge set of a graph G are denoted by $V(G)$ and $E(G)$ so that the order and size of G are respectively $|V(G)|$ and $|E(G)|$. Graph labeling is an assignment of integers to the vertices or edges, or both, subject to certain conditions. Graph labeling plays an important role of various fields of science and few of them are astronomy, coding theory, x-ray crystallography, radar, circuit design, communication network addressing, database management, secret sharing schemes, and models for constraint programming over finite domains [2]. The graph labeling problem was introduced by Rosa and he has introduced graceful labeling of graphs [5] in the year 1967. In 1980, Cahit [1] introduced the cordial labeling of graphs. In 2012, Ponraj et al. [6] introduced the notion of mean cordial labeling. Motivated by these labelings, we introduce a new type of labeling, called total mean cordial labeling. In this paper, we investigate the total mean cordial labeling behaviour of some graphs like path, cycle, wheel, complete graph etc. Let x be any real number. Then the symbol $\lfloor x \rfloor$ stands for the largest integer less than or equal to x and $\lceil x \rceil$ stands for the smallest integer greater than or equal to x .

¹Received April 30, 2014, Accepted December 4, 2014.

§2. Main Results

Definition 2.1 Let f be a function f from $V(G) \rightarrow \{0, 1, 2\}$. For each edge uv , assign the label $\left\lceil \frac{f(u) + f(v)}{2} \right\rceil$. Then, f is called a total mean cordial labeling if $|ev_f(i) - ev_f(j)| \leq 1$ where $ev_f(x)$ denote the total number of vertices and edges labeled with x ($x = 0, 1, 2$). A graph with a total mean cordial labeling is called total mean cordial graph.

Furthermore, let $H \leq G$ be a subgraph of G . If there is a function f from $V(G) \rightarrow \{0, 1, 2\}$ such that $f|_H$ is a total mean cordial labeling but $\left\lceil \frac{f(u) + f(v)}{2} \right\rceil$ is a constant for all edges in $G \setminus H$, such a labeling and G are then respectively called Smarandachely total mean cordial labeling and Smarandachely total mean cordial labeling graph respect to H .

Theorem 2.2 Any Path P_n is total mean cordial.

Proof Let $P_n : u_1 u_2 \cdots u_n$ be the path.

Case 1. $n \equiv 0 \pmod{3}$.

Let $n = 3t$. Define a map $f : V(P_n) \rightarrow \{0, 1, 2\}$ by

$$\begin{cases} f(u_i) & = 0 & 1 \leq i \leq t \\ f(u_{t+i}) & = 1 & 1 \leq i \leq t \\ f(u_{2t+i}) & = 2 & 1 \leq i \leq t. \end{cases}$$

Case 2. $n \equiv 1 \pmod{3}$.

Let $n = 3t + 1$. Define a function $f : V(P_n) \rightarrow \{0, 1, 2\}$ by

$$\begin{cases} f(u_i) & = 0 & 1 \leq i \leq t+1 \\ f(u_{t+1+i}) & = 1 & 1 \leq i \leq t \\ f(u_{2t+1+i}) & = 2 & 1 \leq i \leq t. \end{cases}$$

Case 3. $n \equiv 2 \pmod{3}$.

Let $n = 3t + 2$. Define a function $f : V(P_n) \rightarrow \{0, 1, 2\}$ by

$$\begin{cases} f(u_i) & = 0 & 1 \leq i \leq t+1 \\ f(u_{t+1+i}) & = 1 & 1 \leq i \leq t \\ f(u_{2t+1+i}) & = 2 & 1 \leq i \leq t \end{cases}$$

and $f(u_{3t+2}) = 1$. The following table Table 1 shows that the above vertex labeling f is a total mean cordial labeling.

Nature of n	$ev_f(0)$	$ev_f(1)$	$ev_f(2)$
$n \equiv 0 \pmod{3}$	$2t - 1$	$2t$	$2t$
$n \equiv 1 \pmod{3}$	$2t + 1$	$2t$	$2t$
$n \equiv 2 \pmod{3}$	$2t + 1$	$2t + 1$	$2t + 1$

Table 1

This completes the proof. \square

Theorem 2.3 *The cycle C_n is total mean cordial if and only if $n \neq 3$.*

Proof Let $C_n : u_1u_2 \dots u_nu_1$ be the cycle. If $n = 3$, then we have $ev_f(0) = ev_f(1) = ev_f(2) = 2$. But this is an impossible one. Assume $n > 3$.

Case 1. $n \equiv 0 \pmod{3}$.

Let $n = 3t$, $t > 1$. The labeling given in Figure 1 shows that C_6 is total mean cordial.

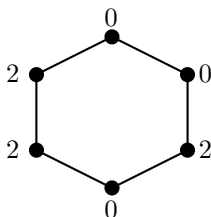

Figure 1

Take $t \geq 3$. Define $f : V(C_n) \rightarrow \{0, 1, 2\}$ by

$$\begin{cases} f(u_i) &= 0 & 1 \leq i \leq t \\ f(u_{t+i}) &= 2 & 1 \leq i \leq t \\ f(u_{2t+i}) &= 1 & 1 \leq i \leq t-2. \end{cases}$$

and $f(u_{3t-1}) = 0$, $f(u_{3t}) = 1$. In this case $ev_f(0) = ev_f(1) = ev_f(2) = 2t$.

Case 2. $n \equiv 1 \pmod{3}$.

The labeling f defined in case 2 of Theorem 2.1 is a total mean cordial labeling of here also. In this case, $ev_f(0) = ev_f(1) = 2t + 1$, $ev_f(2) = 2t$.

Case 3. $n \equiv 2 \pmod{3}$.

The labeling f defined in case 3 of Theorem 2.1 is a total mean cordial labeling. Here, $ev_f(0) = ev_f(2) = 2t + 1$, $ev_f(1) = 2t + 2$. \square

The following three lemmas 2.4–2.6 are used for investigation of total mean cordial labeling of complete graphs.

Lemma 2.4 *There are infinitely many values of n for which $12n^2 + 12n + 9$ is not a perfect square.*

Proof Suppose $12n^2 + 12n + 9$ is a square, α^2 , say. Then $3/\alpha$. So $\alpha = 3\beta$. This implies $12n^2 + 12n + 9 = 9\beta^2$. Hence we obtain $4n^2 + 4n + 3 = 3\beta^2$. On rewriting, we have $(2n + 1)^2 - 3\beta^2 = -2$. Substituting $2n + 1 = U$, $\beta = V$, we get the Pell's equation $U^2 - 3V^2 = -2$. The fundamental solutions of the equations $U^2 - 3V^2 = -2$ and $A^2 - 3B^2 = 1$ are $1 + \sqrt{3}$ and $2 + \sqrt{3}$, respectively. Therefore, all the integral solutions $u_k + \sqrt{3}v_k$ of the equation $U^2 - 3V^2 = -2$ are given by $(1 + \sqrt{3})(2 + \sqrt{3})^k$, where $k = 0, \pm 1, \pm 2, \dots$. Applying the result of Mohanty and Ramasamy [4] on Pell's equation, it is seen that the solutions $u_k + \sqrt{3}v_k$ of the equation $U^2 - 3V^2 = -2$ are proved by the recurrence relationships $u_0 = -1$, $u_1 = 1$, $u_{k+2} = 4u_{k+1} - u_k$ and $v_0 = 1$, $v_1 = 1$, $v_{k+2} = 4v_{k+1} - v_k$. Hence the square values of $12n^2 + 12n + 9$ are given by the sequence $\{n_k\}$ where $n_1 = 0$, $n_2 = 2$, $n_{k+2} = 4n_{k+1} - n_k + 1$. It follows that such of those integers of the form $12m^2 + 12m + 9$ which are not in the sequence $\{n_k\}$ are not perfect squares. \square

Lemma 2.5 *There are infinitely many values of n for which $12n^2 + 12n - 15$ is not a perfect square.*

Proof As in Lemma 2.4 the square values of $12n^2 + 12n - 15$ are given by the sequence $\{n_k\}$ where $n_1 = 1$, $n_2 = 4$, $n_{k+2} = 4n_{k+1} - n_k + 1$. It follows that such of those integers of the form $12m^2 + 12m - 15$ which are not in the sequence $\{n_k\}$ are not perfect squares. \square

Lemma 2.6 *There are infinitely many values of n for which $12n^2 + 12n + 57$ is not a perfect square.*

Proof As in Lemma 2.4 the square values of $12n^2 + 12n + 57$ are given by the sequence $\{n_k\}$ where $n_1 = 1$, $n_2 = 7$, $n_{k+2} = 4n_{k+1} - n_k + 1$. It follows that such of those integers of the form $12m^2 + 12m - 15$ which are not in the sequence $\{n_k\}$ are not perfect squares. \square

Theorem 2.7 *If $n \equiv 0, 2 \pmod{3}$ and $12n^2 + 12n + 9$ is not a perfect square then the complete graph K_n is not total mean cordial.*

Proof Suppose f is a total mean cordial labeling of K_n . Clearly $|V(K_n)| + |E(K_n)| = \frac{n(n+1)}{2}$. If $n \equiv 0, 2 \pmod{3}$ then 3 divides $\frac{n(n+1)}{2}$. Clearly $ev_f(0) = m + \binom{m}{2}$ where $m \in \mathbb{N}$. Then

$$\begin{aligned} \frac{m(m+1)}{2} &= \frac{n(n+1)}{6} \\ \implies m &= \frac{-3 \pm \sqrt{12n^2 + 12n + 9}}{2}, \end{aligned}$$

a contradiction since $12n^2 + 12n + 9$ is not a perfect square. \square

Theorem 2.8 *If $n \equiv 1 \pmod{3}$, $12n^2 + 12n - 15$ and $12n^2 + 12n + 57$ are not perfect squares then the complete graph K_n is not total mean cordial.*

Proof Suppose there exists a total mean cordial labeling of K_n , say f . It is clear that $ev_f(0) = \frac{n^2 + n - 2}{6}$ or $ev_f(0) = \frac{n^2 + n + 4}{6}$.

Case 1. $ev_f(0) = \frac{n^2 + n - 2}{6} = m.$

Suppose k zeros are used in the vertices. Then $k + \binom{k}{2} = m$ where $k \in \mathbb{N}$.

$$\begin{aligned} \implies k(k+1) &= \frac{n^2 + n - 2}{3} \\ \implies 3k^2 + 3k - (n^2 + n - 2) &= 0 \\ \implies k &= \frac{-3 \pm \sqrt{12n^2 + 12n - 15}}{6}. \end{aligned}$$

a contradiction since $12n^2 + 12n - 15$ is not a perfect square.

Case 2. $ev_f(0) = \frac{n^2 + n + 4}{6} = m.$

Suppose k zeros are used in the vertices. Then $k + \binom{k}{2} = m$ where $k \in \mathbb{N}$.

$$\begin{aligned} \implies k(k+1) &= \frac{n^2 + n + 4}{3} \\ \implies 3k^2 + 3k - (n^2 + n + 4) &= 0 \\ \implies k &= \frac{-3 \pm \sqrt{12n^2 + 12n + 57}}{6}. \end{aligned}$$

a contradiction since $12n^2 + 12n + 57$ is not a perfect square. □

Theorem 2.9 *The complete graph K_n is not total mean cordial for infinitely many values of n .*

Proof Proof follow from Lemmas 2.4 – 2.6 and Theorems 2.7 – 2.8. □

Theorem 2.10 *The star $K_{1,n}$ is total mean cordial.*

Proof Let $V(K_{1,n}) = \{u, u_i : 1 \leq i \leq n\}$ and $E(K_{1,n}) = \{uu_i : 1 \leq i \leq n\}$. Define a map $f : V(K_{1,n}) \rightarrow \{0, 1, 2\}$ by $f(u) = 0$,

$$\begin{cases} f(u_i) &= 0 & 1 \leq i \leq \lfloor \frac{n}{3} \rfloor \\ f(u_{\lfloor \frac{n}{3} \rfloor + i}) &= 2 & 1 \leq i \leq \lceil \frac{2n}{3} \rceil \end{cases}$$

The Table 2 shows that f is a total mean cordial labeling.

Values of n	$ev_f(0)$	$ev_f(1)$	$ev_f(2)$
$n \equiv 0 \pmod{3}$	$\frac{2n+3}{3}$	$\frac{2n}{3}$	$\frac{2n}{3}$
$n \equiv 1 \pmod{3}$	$\frac{2n+1}{3}$	$\frac{2n+1}{3}$	$\frac{2n+1}{3}$
$n \equiv 2 \pmod{3}$	$\frac{2n-1}{3}$	$\frac{2n+2}{3}$	$\frac{2n+2}{3}$

Table 2

This completes the proof. □

The join of two graphs G_1 and G_2 is denoted by $G_1 + G_2$ with

$$V(G_1 + G_2) = V(G_1) \cup V(G_2),$$

$$E(G_1 + G_2) = E(G_1) \cup E(G_2) \cup \{uv : u \in V(G_1), v \in V(G_2)\}.$$

Theorem 2.11 *The wheel $W_n = C_n + K_1$ is total mean cordial if and only if $n \neq 4$.*

Proof Let $C_n : u_1u_2 \dots u_nu_1$ be the cycle. Let $V(W_n) = V(C_n) \cup \{u\}$ and $E(W_n) = E(C_n) \cup \{uu_i : 1 \leq i \leq n\}$. Here $|V(W_n)| = n + 1$ and $|E(W_n)| = 2n$.

Case 1. $n \equiv 0 \pmod{6}$.

Let $n = 6k$ where $k \in \mathbb{N}$. Define a map $f : V(W_n) \rightarrow \{0, 1, 2\}$ by $f(u) = 0$,

$$\begin{cases} f(u_i) &= 0 & 1 \leq i \leq 2k \\ f(u_{5k+i}) &= 1 & 1 \leq i \leq k \\ f(u_{2k+i}) &= 2 & 1 \leq i \leq 3k. \end{cases}$$

In this case, $ev_f(0) = ev_f(2) = 6k$, $ev_f(1) = 6k + 1$.

Case 2. $n \equiv 1 \pmod{6}$.

Let $n = 6k - 5$ where $k \in \mathbb{N}$ and $k > 1$. Suppose $k = 2$ then the Figure 2 shows that W_7 is total mean cordial.

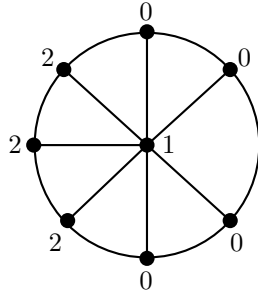

Figure 2

Assume $k > 2$. Define a function $f : V(W_n) \rightarrow \{0, 1, 2\}$ by $f(u) = 0$ and

$$f(u_i) = \begin{cases} 0 & \text{if } 1 \leq i \leq 2k - 2 \text{ \& } i = 5k - 3 \\ 1 & \text{if } 5k - 2 \leq i \leq 6k - 5 \\ 2 & \text{if } 2k - 1 \leq i \leq 5k - 4. \end{cases}$$

It is clear that $ev_f(0) = 6k - 4$, $ev_f(1) = ev_f(2) = 6k - 5$.

Case 3. $n \equiv 2 \pmod{6}$.

Let $n = 6k - 4$ where $k \in \mathbb{N}$ and $k > 1$. Define $f : V(W_n) \rightarrow \{0, 1, 2\}$ by $f(u) = 0$ and

$$f(u_i) = \begin{cases} 0 & \text{if } 1 \leq i \leq 2k - 1 \\ 1 & \text{if } 5k - 2 \leq i \leq 6k - 4 \\ 2 & \text{if } 2k \leq i \leq 5k - 3. \end{cases}$$

Note that $ev_f(0) = 6k - 3$, $ev_f(1) = ev_f(2) = 6k - 4$.

Case 4. $n \equiv 3 \pmod{6}$.

Let $n = 6k - 3$ where $k \in \mathbb{N}$. Define a function $f : V(W_n) \rightarrow \{0, 1, 2\}$ by $f(u) = 0$,

$$\begin{cases} f(u_i) & = 0 & 1 \leq i \leq 2k - 1 \\ f(u_{5k-2+i}) & = 1 & 1 \leq i \leq k - 1 \\ f(u_{2k-1+i}) & = 2 & 1 \leq i \leq 3k - 1. \end{cases}$$

In this case $ev_f(0) = ev_f(1) = 6k - 3$, $ev_f(2) = 6k - 2$.

Case 5. $n \equiv 4 \pmod{6}$.

When $n = 4$ it is easy to verify that the total mean cordiality condition is not satisfied. Let $n = 6k - 2$ where $k \in \mathbb{N}$ and $k > 1$. From Figure 3, it is clear that $ev_f(0) = 11$, $ev_f(1) = ev_f(2) = 10$ and hence W_{10} is total mean cordial.

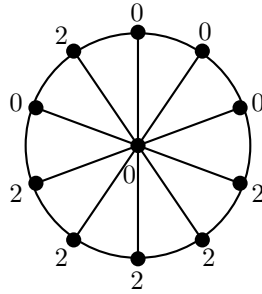

Figure 3

Let $k \geq 3$. Define a function $f : V(W_n) \rightarrow \{0, 1, 2\}$ by $f(u) = 0$, $f(u_{6k-3}) = 0$, $f(u_{6k-2}) = 1$ and

$$\begin{cases} f(u_i) & = 0 & 1 \leq i \leq 2k - 1 \\ f(u_{5k-2+i}) & = 1 & 1 \leq i \leq k - 2 \\ f(u_{2k-1+i}) & = 2 & 1 \leq i \leq 3k - 1. \end{cases}$$

In this case $ev_f(0) = 6k - 1$, $ev_f(1) = ev_f(2) = 6k - 2$.

Case 6. $n \equiv 5 \pmod{6}$.

Let $n = 6k - 1$ where $k \in \mathbb{N}$. For $k = 1$ the Figure 4 shows that W_5 is total mean cordial.

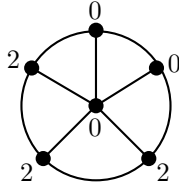

Figure 4

Assume $k \geq 2$. Define a function $f : V(W_n) \rightarrow \{0, 1, 2\}$ by $f(u) = 0$ and

$$f(u_i) = \begin{cases} 0 & \text{if } 1 \leq i \leq 2k \\ 1 & \text{if } 5k + 1 \leq i \leq 6k - 1 \text{ \& } i = 2k + 1 \\ 2 & \text{if } 2k + 2 \leq i \leq 5k. \end{cases}$$

It is clear that $ev_f(0) = 6k$, $ev_f(1) = ev_f(2) = 6k - 1$. □

Theorem 2.12 $K_2 + mK_1$ is total mean cordial if and only if m is even.

Proof Clearly $|V(K_2 + mK_1)| = 3m + 3$. Let $V(K_2 + mK_1) = \{u, v, u_i : 1 \leq i \leq m\}$ and $E(K_2 + mK_1) = \{uv, uu_i, vu_i : 1 \leq i \leq m\}$.

Case 1. m is even.

Let $m = 2t$. Define $f : V(K_2 + mK_1) \rightarrow \{0, 1, 2\}$ by $f(u) = 0$, $f(v) = 2$

$$\begin{cases} f(u_i) & = 0 & 1 \leq i \leq t \\ f(u_{t+i}) & = 2 & 1 \leq i \leq t. \end{cases}$$

Then $ev_f(0) = ev_f(1) = ev_f(2) = 2t + 1$ and hence f is a total mean cordial labeling.

Case 2. m is odd.

Let $m = 2t + 1$. Suppose f is a total mean cordial labeling, then $ev_f(0) = ev_f(1) = ev_f(2) = 2t + 2$.

Subcase 1. $f(u) = 0$ and $f(v) = 0$.

Then $ev_f(2) \leq 2t + 1$, a contradiction.

Subcase 2. $f(u) = 0$ and $f(v) \neq 0$.

Since the vertex u has label 0, we have only $2t + 1$ zeros. While counting the total number of zeros each vertices u_i along with the edges uu_i contributes 2 zeros. This implies $ev_f(0)$ is an odd number, a contradiction.

Subcase 3. $f(u) \neq 0$ and $f(v) \neq 0$.

Then $ev_f(0) \leq 2t + 1$, a contradiction. □

The corona of G with H , $G \odot H$ is the graph obtained by taking one copy of G and p copies

of H and joining the i^{th} vertex of G with an edge to every vertex in the i^{th} copy of H . $C_n \odot K_1$ is called the crown, $P_n \odot K_1$ is called the comb and $P_n \odot 2K_1$ is called the double comb.

Theorem 2.13 *The comb $P_n \odot K_1$ admits a total mean cordial labeling.*

Proof Let $P_n : u_1 u_2 \dots u_n$ be the path. Let $V(P_n \odot K_1) = \{V(P_n) \cup \{v_i : 1 \leq i \leq n\}$ and $E(P_n \odot K_1) = E(P_n) \cup \{u_i v_i : 1 \leq i \leq n\}$. Note that $|V(P_n \odot K_1)| + |E(P_n \odot K_1)| = 4n - 1$.

Case 1. $n \equiv 0 \pmod{3}$.

Let $n = 3t$. Define a map $f : V(P_n \odot K_1) \rightarrow \{0, 1, 2\}$ by

$$\begin{cases} f(u_i) & = 0 & 1 \leq i \leq 2t \\ f(u_{2t+i}) & = 1 & 1 \leq i \leq t \\ f(v_i) & = 2 & 1 \leq i \leq 3t. \end{cases}$$

Case 2. $n \equiv 1 \pmod{3}$.

Let $n = 3t + 1$. Define a function $f : V(P_n \odot K_1) \rightarrow \{0, 1, 2\}$ by

$$\begin{cases} f(u_i) & = 0 & 1 \leq i \leq 2t + 1 \\ f(u_{2t+1+i}) & = 1 & 1 \leq i \leq t \\ f(v_i) & = 2 & 1 \leq i \leq 3t + 1. \end{cases}$$

Case 3. $n \equiv 2 \pmod{3}$.

Let $n = 3t + 2$. Define a function $f : V(P_n \odot K_1) \rightarrow \{0, 1, 2\}$ by

$$\begin{cases} f(u_i) & = 0 & 1 \leq i \leq 2t + 2 \\ f(u_{2t+2+i}) & = 1 & 1 \leq i \leq t \\ f(v_i) & = 2 & 1 \leq i \leq 3t + 2. \end{cases}$$

From Table 3 it is easy that the labeling f is a total mean cordial labeling.

Nature of n	$ev_f(0)$	$ev_f(1)$	$ev_f(2)$
$n \equiv 0 \pmod{3}$	$4t - 1$	$4t$	$4t$
$n \equiv 1 \pmod{3}$	$4t + 1$	$4t + 1$	$4t + 1$
$n \equiv 2 \pmod{3}$	$4t + 3$	$4t + 2$	$4t + 2$

Table 3

This completes the proof. □

Theorem 2.14 *The double comb $P_n \odot 2K_1$ is total mean cordial.*

Proof Let $P_n : u_1 u_2 \dots u_n$ be the path. Let $V(P_n \odot 2K_1) = \{V(P_n) \cup \{v_i, w_i : 1 \leq$

$i \leq n\}$ and $E(P_n \odot 2K_1) = E(P_n) \cup \{u_i v_i, u_i w_i : 1 \leq i \leq n\}$. Note that $|V(P_n \odot 2K_1)| + |E(P_n \odot 2K_1)| = 6n - 1$.

Case 1. $n \equiv 0 \pmod{3}$.

Let $n = 3t$. Define a map $f : V(P_n \odot 2K_1) \rightarrow \{0, 1, 2\}$ by

$$\begin{cases} f(u_i) & = f(v_i) & = f(w_i) & = 0 & 1 \leq i \leq t \\ f(u_{t+i}) & = f(v_{t+i}) & = f(w_{t+i}) & = 1 & 1 \leq i \leq t \\ f(u_{2t+i}) & = f(v_{2t+i}) & = f(w_{2t+i}) & = 2 & 1 \leq i \leq t \end{cases}$$

Case 2. $n \equiv 1 \pmod{3}$.

Let $n = 3t + 1$. Define a function $f : V(P_n \odot 2K_1) \rightarrow \{0, 1, 2\}$ by

$$\begin{cases} f(u_i) & = 0 & 1 \leq i \leq t+1 \\ f(u_{t+1+i}) & = 1 & 1 \leq i \leq t \\ f(u_{2t+1+i}) & = 2 & 1 \leq i \leq t \\ f(v_i) & = 0 & 1 \leq i \leq t \\ f(v_{t+i}) & = 1 & 1 \leq i \leq t+1 \\ f(v_{2t+1+i}) & = 2 & 1 \leq i \leq t \\ f(w_i) & = 0 & 1 \leq i \leq t \\ f(w_{t+i}) & = 1 & 1 \leq i \leq t \\ f(w_{2t+i}) & = 2 & 1 \leq i \leq t+1 \end{cases}$$

Case 3. $n \equiv 2 \pmod{3}$.

Let $n = 3t + 2$. Define a function $f : V(P_n \odot 2K_1) \rightarrow \{0, 1, 2\}$ by

$$\begin{cases} f(u_i) & = 0 & 1 \leq i \leq t+1 \\ f(u_{t+1+i}) & = 1 & 1 \leq i \leq t+1 \\ f(u_{2t+2+i}) & = 2 & 1 \leq i \leq t \\ f(v_i) & = 0 & 1 \leq i \leq t+1 \\ f(v_{t+1+i}) & = 1 & 1 \leq i \leq t \\ f(v_{2t+1+i}) & = 2 & 1 \leq i \leq t+1 \\ f(w_i) & = 0 & 1 \leq i \leq t \\ f(w_{t+i}) & = 1 & 1 \leq i \leq t+1 \\ f(w_{2t+1+i}) & = 2 & 1 \leq i \leq t+1 \end{cases}$$

The Table 4 shows that the labeling f is a total mean cordial labeling.

Nature of n	$ev_f(0)$	$ev_f(1)$	$ev_f(2)$
$n \equiv 0 \pmod{3}$	$6t - 1$	$6t$	$6t$
$n \equiv 1 \pmod{3}$	$6t + 1$	$6t + 2$	$6t + 2$
$n \equiv 2 \pmod{3}$	$6t + 3$	$6t + 4$	$6t + 4$

Table 4

This completes the proof. \square

Theorem 2.15 *The crown $C_n \odot K_1$ is total mean cordial.*

Proof Let $C_n : u_1u_2 \dots u_nu_1$ be the cycle. Let $V(C_n \odot K_1) = \{V(C_n) \cup \{v_i : 1 \leq i \leq n\}$ and $E(C_n \odot K_1) = E(C_n) \cup \{u_iv_i : 1 \leq i \leq n\}$. Note that $|V(C_n \odot K_1)| + |E(C_n \odot K_1)| = 4n$.

Case 1. $n \equiv 0 \pmod{3}$.

Let $n = 3t$. For $t = 1$ we refer Figure 5.

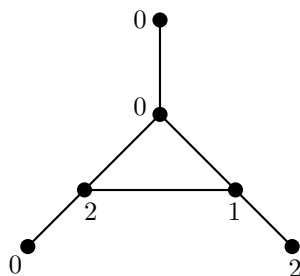

Figure 5

Let $t > 1$. Define a map $f : V(C_n \odot K_1) \rightarrow \{0, 1, 2\}$ by

$$\begin{cases} f(u_i) & = f(v_i) & = 0 & 1 \leq i \leq t \\ f(u_{t+i}) & = f(v_{t+i}) & = 1 & 1 \leq i \leq t-1 \\ f(u_{2t-1+i}) & = f(v_{2t-1+i}) & = 2 & 1 \leq i \leq t-1 \end{cases}$$

and $f(u_{3t-1}) = 2, f(u_{3t}) = 1, f(v_{3t-1}) = 1, f(v_{3t}) = 0$. Here $ev_f(0) = ev_f(1) = ev_f(2) = 4t$.

Case 2. $n \equiv 1 \pmod{3}$.

The labeling f defined in case 2 of Theorem 2.13 is a total mean cordial labeling. Here, $ev_f(0) = 4t + 1, ev_f(1) = 4t + 2, ev_f(2) = 4t + 1$.

Case 3. $n \equiv 2 \pmod{3}$.

The labeling f defined in case 3 of Theorem 2.13 is a total mean cordial labeling. Here, $ev_f(0) = ev_f(1) = 4t + 3, ev_f(2) = 4t + 2$. \square

The triangular snake T_n is obtained from the path P_n by replacing every edge of the path by a triangle.

Theorem 2.16 *The triangular snake T_n is total mean cordial if and only if $n > 2$.*

Proof Let $P_n : u_1u_2 \dots u_n$ be the path and $V(T_n) = V(P_n) \cup \{v_i : 1 \leq i \leq n-1\}$. Let $E(T_n) = E(P_n) \cup \{u_iv_i, v_iu_{i+1} : 1 \leq i \leq n-1\}$. If $n = 2$, $T_2 \cong C_3$, by Theorem 2.3, T_2 is not total mean cordial. Let $n \geq 3$. Here $|V(T_n)| + |E(T_n)| = 5n - 4$.

Case 1. $n \equiv 0 \pmod{3}$.

Let $n = 3t$. For T_3 , the vertex labeling in Figure 6 is a total mean cordial labeling.

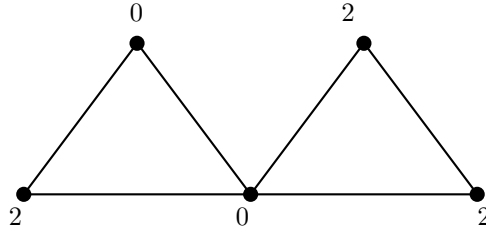

Figure 6

Let $t \geq 2$. Define a map $f : V(T_n) \rightarrow \{0, 1, 2\}$ by

$$\left\{ \begin{array}{ll} f(u_i) & = 0 \quad 1 \leq i \leq t \\ f(u_{t+i}) & = 1 \quad 1 \leq i \leq t \\ f(u_{2t+i}) & = 2 \quad 1 \leq i \leq t-1 \\ f(v_i) & = 0 \quad 1 \leq i \leq t \\ f(v_{t+i}) & = 1 \quad 1 \leq i \leq t-1 \\ f(v_{2t-1+i}) & = 2 \quad 1 \leq i \leq t \end{array} \right.$$

and $f(u_{3t}) = 1$.

Case 2. $n \equiv 1 \pmod{3}$.

Let $n = 3t + 1$. Define $f : V(T_n) \rightarrow \{0, 1, 2\}$ by

$$\left\{ \begin{array}{ll} f(u_i) & = 0 \quad 1 \leq i \leq t+1 \\ f(u_{t+1+i}) & = 1 \quad 1 \leq i \leq t \\ f(u_{2t+1+i}) & = 2 \quad 1 \leq i \leq t \\ f(v_i) & = 0 \quad 1 \leq i \leq t \\ f(v_{t+i}) & = 1 \quad 1 \leq i \leq t \\ f(v_{2t+i}) & = 2 \quad 1 \leq i \leq t \end{array} \right.$$

Case 3. $n \equiv 2 \pmod{3}$.

Let $n = 3t + 2$. Define $f : V(T_n) \rightarrow \{0, 1, 2\}$ by

$$\left\{ \begin{array}{ll} f(u_i) & = 0 \quad 1 \leq i \leq t+1 \\ f(u_{t+1+i}) & = 2 \quad 1 \leq i \leq t \\ f(u_{2t+1+i}) & = 1 \quad 1 \leq i \leq t \\ f(v_i) & = 0 \quad 1 \leq i \leq t \\ f(v_{t+i}) & = 2 \quad 1 \leq i \leq t+1 \\ f(v_{2t+1+i}) & = 1 \quad 1 \leq i \leq t \end{array} \right.$$

and $f(u_{3t+2}) = 0$. The Table 5 shows that T_n is total mean cordial.

Nature of n	$ev_f(0)$	$ev_f(1)$	$ev_f(2)$
$n \equiv 0 \pmod{3}$	$5t - 2$	$5t - 1$	$5t - 1$
$n \equiv 1 \pmod{3}$	$5t + 1$	$5t$	$5t$
$n \equiv 2 \pmod{3}$	$5t + 2$	$5t + 2$	$5t + 2$

Table 5

This completes the proof. □

References

- [1] I.Cahit, Cordial graphs: a weaker version of graceful and harmonious graphs, *Ars combin.*, 23(1987) 201-207.
- [2] J.A.Gallian, A dynamic survey of graph labeling, *The Electronic Journal of Combinatorics*, 16(2013) # Ds6.
- [3] F.Harary, *Graph theory*, Addison wesley, New Delhi, 1969.
- [4] S.P.Mohanty and A.M.S.Ramasamy, The characteristic number of two simultaneous Pell's equations and its applications, *Simon Stevin*, 59(1985), 203-214.
- [5] A.Rosa, On certain valuations of the vertices of a graph, *Theory of Graphs (Internat. Symposium, Rome, July 1966)*, Gordon and Breach N.Y. and Dunod Paris (1967) 349-355.
- [6] R.Ponraj, M.Sivakumar and M.Sundaram, Mean Cordial labeling of graphs, *Open Journal of Discrete Mathematics*, 2(2012), 145-148.

Smarandache's Conjecture on Consecutive Primes

Octavian Cira

(Aurel Vlaicu, University of Arad, Romania)

E-mail: octavian.cira@uav.ro

Abstract: Let p and q two consecutive prime numbers, where $q > p$. Smarandache's conjecture states that the nonlinear equation $q^x - p^x = 1$ has solutions > 0.5 for any p and q consecutive prime numbers. This article describes the conditions that must be fulfilled for Smarandache's conjecture to be true.

Key Words: Smarandache conjecture, Smarandache constant, prime, gap of consecutive prime.

AMS(2010): 11A41

§1. Introduction

We note $\mathbb{P}_{\geq k} = \{p \mid p \text{ prime number, } p \geq k\}$ and two consecutive prime numbers $p_n, p_{n+1} \in \mathbb{P}_{\geq 2}$.

Smarandache Conjecture *The equation*

$$p_{n+1}^x - p_n^x = 1, \quad (1.1)$$

has solutions > 0.5 , for any $n \in \mathbb{N}^$ ([18], [25]).*

Smarandache's constant([18], [29]) is $c_S \approx 0.567148130202539 \dots$, the solution for the equation

$$127^x - 113^x = 1.$$

Smarandache Constant Conjecture *The constant c_S is the smallest solution of equation (1.1) for any $n \in \mathbb{N}^*$.*

The function that counts the the prime numbers p , $p \leq x$, was denoted by Edmund Landau in 1909, by π ([10], [27]). The notation was adopted in this article.

We present some conjectures and theorems regarding the distribution of prime numbers.

Legendre Conjecture([8], [20]) *For any $n \in \mathbb{N}^*$ there is a prime number p such that*

$$n^2 < p < (n + 1)^2.$$

¹Received August 15, 2014, Accepted December 5, 2014.

The smallest primes between n^2 and $(n+1)^2$ for $n = 1, 2, \dots$, are 2, 5, 11, 17, 29, 37, 53, 67, 83, \dots , [24, A007491].

The largest primes between n^2 and $(n+1)^2$ for $n = 1, 2, \dots$, are 3, 7, 13, 23, 31, 47, 61, 79, 97, \dots , [24, A053001].

The numbers of primes between n^2 and $(n+1)^2$ for $n = 1, 2, \dots$ are given by 2, 2, 2, 3, 2, 4, 3, 4, \dots , [24, A014085].

Bertrand Theorem *For any integer n , $n > 3$, there is a prime p such that $n < p < 2(n-1)$.*

Bertrand formulated this theorem in 1845. This assumption was proven for the first time by Chebyshev in 1850. Ramanujan in 1919 ([19]), and Erdős in 1932 ([5]), published two simple proofs for this theorem.

Bertrand's theorem stated that: *for any $n \in \mathbb{N}^*$ there is a prime p , such that $n < p < 2n$.* In 1930, Hoheisel, proved that there is $\theta \in (0, 1)$ ([9]), such that

$$\pi(x + x^\theta) - \pi(x) \approx \frac{x^\theta}{\ln(x)}. \quad (1.2)$$

Finding the smallest interval that contains at least one prime number p , was a very hot topic. Among the most recent results belong to Andy Loo whom in 2011 ([11]) proved any for $n \in \mathbb{N}^*$ there is a prime p such that $3n < p < 4n$. Even ore so, we can state that, if Riemann's hypothesis

$$\pi(x) = \int_2^x \frac{du}{\ln(u)} + O(\sqrt{x} \ln(x)), \quad (1.3)$$

stands, then in (1.2) we can consider $\theta = 0.5 + \varepsilon$, according to Maier ([12]).

Brocard Conjecture([17,26]) *For any $n \in \mathbb{N}^*$ the inequality*

$$\pi(p_{n+1}^2) - \pi(p_n^2) \geq 4$$

holds.

Legendre's conjecture stated that between p_n^2 and a^2 , where $a \in (p_n, p_{n+1})$, there are at least two primes and that between a^2 and p_{n+1}^2 there are also at least two prime numbers. Namely, is Legendre's conjecture stands, then there are at least four prime numbers between p_n^2 and p_{n+1}^2 .

Concluding, if Legendre's conjecture stands then Brocard's conjecture is also true.

Andrica Conjecture([1],[13],[17]) *For any $n \in \mathbb{N}^*$ the inequality*

$$\sqrt{p_{n+1}} - \sqrt{p_n} < 1, \quad (1.4)$$

stands.

The relation (1.4) is equivalent to the inequality

$$\sqrt{p_n + g_n} < \sqrt{p_n} + 1, \quad (1.5)$$

where we denote by $g_n = p_{n+1} - p_n$ the gap between p_{n+1} and p_n . Squaring (1.5) we obtain the equivalent relation

$$g_n < 2\sqrt{p_n} + 1 . \quad (1.6)$$

Therefore Andrica's conjecture equivalent form is: *for any $n \in \mathbb{N}^*$ the inequality (1.6) is true.*

In 2014 Paz ([17]) proved that if Legendre's conjecture stands then Andrica's conjecture is also fulfilled. Smarandache's conjecture is a generalization of Andrica's conjecture ([25]).

Cramér Conjecture([4, 7, 21, 23]) *For any $n \in \mathbb{N}^*$*

$$g_n = O(\ln(p_n)^2) , \quad (1.7)$$

where $g_n = p_{n+1} - p_n$, namely

$$\limsup_{n \rightarrow \infty} \frac{g_n}{\ln(p_n)^2} = 1 .$$

Cramér proved that

$$g_n = O(\sqrt{p_n} \ln(p_n)) ,$$

a much weaker relation (1.7), by assuming Riemann hypothesis (1.3) to be true.

Westzynthius proved in 1931 that the gaps g_n grow faster than the prime numbers logarithmic curve ([30]), namely

$$\limsup_{n \rightarrow \infty} \frac{g_n}{\ln(p_n)} = \infty .$$

Cramér-Granville Conjecture *For any $n \in \mathbb{N}^*$*

$$g_n < R \cdot \ln(p_n)^2 , \quad (1.8)$$

stands for $R > 1$, where $g_n = p_{n+1} - p_n$.

Using Maier's theorem, Granville proved that Cramér's inequality (1.8) does not accurately describe the prime numbers distribution. Granville proposed that $R = 2e^{-\gamma} \approx 1.123 \dots$ considering the small prime numbers ([6, 13]) (a prime number is considered small if $p < 10^6$, [3]).

Nicely studied the validity of Cramér-Granville's conjecture, by computing the ratio

$$R = \frac{\ln(p_n)}{\sqrt{g_n}} ,$$

using large gaps. He noted that for this kind of gaps $R \approx 1.13 \dots$. Since $1/R^2 < 1$, using the ratio R we can not produce a proof for Cramér-Granville's conjecture ([14]).

Oppermann Conjecture([16],[17]) *For any $n \in \mathbb{N}^*$, the intervals*

$$[n^2 - n + 1, n^2 - 1] \quad \text{and} \quad [n^2 + 1, n^2 + n]$$

contain at least one prime number p .

Firoozbakht Conjecture For any $n \in \mathbb{N}^*$ we have the inequality

$${}^{n+1}\sqrt{p_{n+1}} < \sqrt[n]{p_n} \quad (1.9)$$

or its equivalent form

$$p_{n+1} < p_n^{1+\frac{1}{n}} .$$

If Firoozbakht's conjecture stands, then for any $n > 4$ we the inequality

$$g_n < \ln(p_n)^2 - \ln(p_n) , \quad (1.10)$$

is true, where $g_n = p_{n+1} - p_n$. In 1982 Firoozbakht verified the inequality (1.10) using maximal gaps up to 4.444×10^{12} ([22]), namely close to the 48th position in Table 1.

Currently the table was completed up to the position 75 ([15, 24]).

Paz Conjecture([17]) *If Legendre's conjecture stands then:*

- (1) *The interval $[n, n + 2\lfloor\sqrt{n}\rfloor + 1]$ contains at least one prime number p for any $n \in \mathbb{N}^*$;*
- (2) *The interval $[n - \lfloor\sqrt{n}\rfloor + 1, n]$ or $[n, n + \lfloor\sqrt{n}\rfloor - 1]$ contains at least one prime number p , for any $n \in \mathbb{N}^*$, $n > 1$.*

Remark 1.1 According to Case (1) and (2), if Legendre's conjecture holds, then Andrica's conjecture is also true ([17]).

Conjecture Wolf *Furthermore, the bounds presented below suggest yet another growth rate, namely, that of the square of the so-called Lambert W function. These growth rates differ by very slowly growing factors (like $\ln(\ln(p_n))$). Much more data is needed to verify empirically which one is closer to the true growth rate.*

Let $P(g)$ be the least prime such that $P(g) + g$ is the smallest prime larger than $P(g)$. The values of $P(g)$ are bounded, for our empirical data, by the functions

$$P_{min}(g) = 0.12 \cdot \sqrt{g} \cdot e^{\sqrt{g}} ,$$

$$P_{max}(g) = 30.83 \cdot \sqrt{g} \cdot e^{\sqrt{g}} .$$

For large g , there bounds are in accord with a conjecture of Marek Wolf ([15, 31, 32]).

§2. Proof of Smarandache Conjecture

In this article we intend to prove that there are no equations of type (1.1), in respect to x with solutions ≤ 0.5 for any $n \in \mathbb{N}^*$.

Let $f : [0, 1] \rightarrow \mathbb{R}$,

$$f(x) = (p + g)^x - p^x - 1 , \quad (2.1)$$

where $p \in \mathbb{P}_{\geq 3}$, $g \in \mathbb{N}^*$ and g the gap between p and the consecutive prime number $p + g$. Thus

the equation

$$(p + g)^x - p^x = 1 . \tag{2.2}$$

is equivalent to equation (1.1).

Since for any $p \in \mathbb{P}_{\geq 3}$ we have $g \geq 2$ (if *Goldbach's conjecture* is true, then $g = 2 \cdot \mathbb{N}^{*1}$).

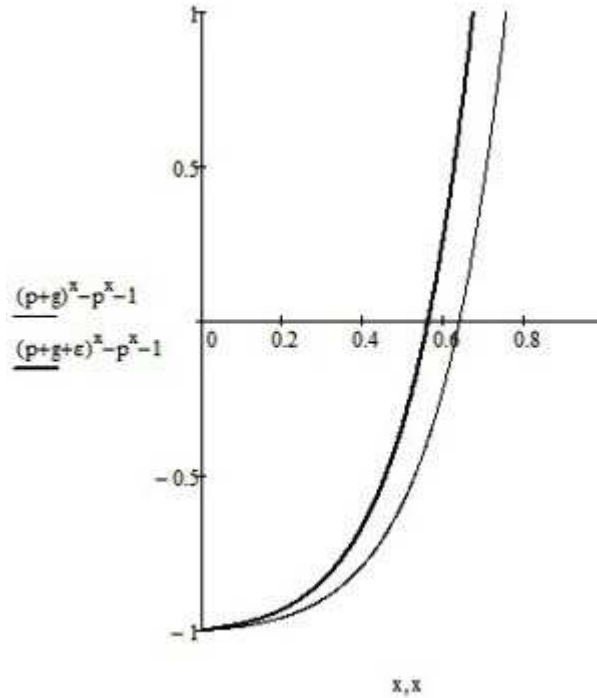

Figure 1 The functions (2.1) and $(p + g + \epsilon)^x - p^x - 1$ for $p = 89$, $g = 8$ and $\epsilon = 5$

Theorem 2.1 *The function f given by (2.1) is strictly increasing and convex over its domain.*

Proof If we compute the first and second derivative of function f , namely

$$f'(x) = \ln(p + g)(p + g)^x - \ln(p)p^x$$

and

$$f''(x) = \ln(p + g)^2(p + g)^x - \ln(p)^2p^x .$$

it follows that $f'(x) > 0$ and $f''(x) > 0$ over $[0, 1]$, thus function f is strictly increasing and convex over its domain. □

Corollary 2.2 *Since $f(0) = -1 < 0$ and $f(1) = g - 1 > 0$ because $g \geq 2$ if $p \in \mathbb{P}_{\geq 3}$ and, also since function f is strictly monotonically increasing function it follows that equation (2.2) has a unique solution over the interval $(0, 1)$.*

¹ $2 \cdot \mathbb{N}^*$ is the set of all even natural numbers

Theorem 2.3 For any g that verifies the condition $2 \leq g < 2\sqrt{p} + 1$, function $f(0.5) < 0$.

Proof The inequality $\sqrt{p+g} - \sqrt{p} - 1 < 0$ in respect to g had the solution $-p \leq g < 2\sqrt{p} + 1$. Considering the give condition it follows that for a given g that fulfills $2 \leq g < 2\sqrt{p} + 1$ we have $f(0.5) < 0$ for any $p \in \mathbb{P}_{\geq 3}$. \square

Remark 2.4 The condition $g < 2\sqrt{p} + 1$ represent Andrica's conjecture (1.6).

Theorem 2.5 Let $p \in \mathbb{P}_{\geq 3}$ and $g \in \mathbb{N}^*$, then the equation (2.2) has a greater solution s then s_ε , the solution for the equation $(p+g+\varepsilon)^x - p^x - 1 = 0$, for any $\varepsilon > 0$.

Proof Let $\varepsilon > 0$, then $p+g+\varepsilon > p+g$. It follows that $(p+g+\varepsilon)^x - p^x - 1 > (p+g)^x - p^x - 1$, for any $x \in [0, 1]$. Let s be the solution to equation (2.2), then there is $\delta > 0$, that depends on ε , such that $(p+g+\varepsilon)^{s-\delta} - p^{s-\delta} - 1 = 0$. Therefore s , the solution for equation (2.2), is greater that the solution $s_\varepsilon = s - \delta$ for the equation $(p+g+\varepsilon)^x - p^x - 1 = 0$, see Figure 1. \square

Theorem 2.6 Let $p \in \mathbb{P}_{\geq 3}$ and $g \in \mathbb{N}^*$, then $s < s_\varepsilon$, where s is the equation solution (2.2) and s_ε is the equation solution $(p+\varepsilon+g)^x - (p+\varepsilon)^x - 1 = 0$, for any $\varepsilon > 0$.

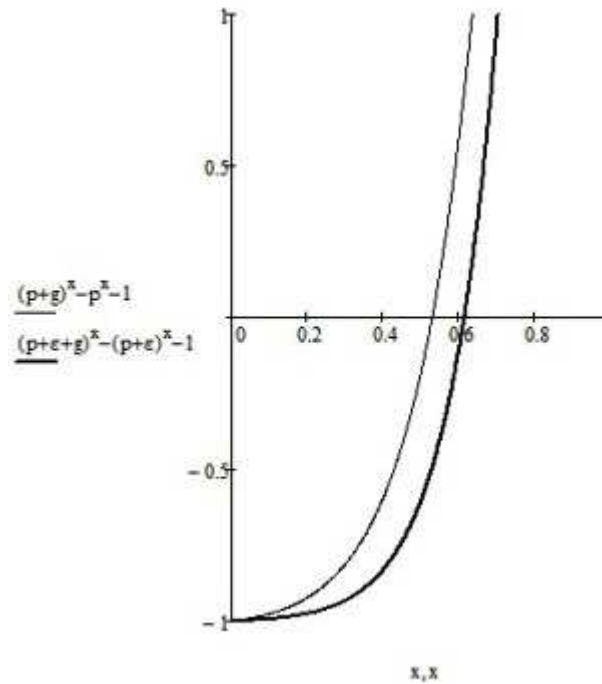

Figure 2 The functions (2.1) and $(p+\varepsilon+g)^x - (p+\varepsilon)^x - 1$ for $p = 113, \varepsilon = 408, g = 14$

Proof Let $\varepsilon > 0$, Then $p+\varepsilon+g > p+g$, from which it follows that $(p+\varepsilon+g)^x - (p+\varepsilon)^x - 1 < (p+g)^x - p^x - 1$, for any $x \in [0, 1]$ (see Figure 2). Let s the equation solution (2.2), then there $\delta > 0$, which depends on ε , so $(p+\varepsilon+g)^{s+\delta} - (p+\varepsilon)^{s+\delta} - 1 = 0$. Therefore the solution s , of the equation (2.2), is lower than the solution $s_\varepsilon = s + \delta$ of the equation $(p+\varepsilon+g)^x - (p+\varepsilon)^x - 1 = 0$, see Figure 2. \square

Remark 2.7 Let p_n and p_{n+1} two prime numbers in Table maximal gaps corresponding the maximum gap g_n . The Theorem 2.6 allows us to say that all solutions of the equation $(q + \gamma)^x - q^x = 1$, where $q \in \{p_n, \dots, p_{n+1} - 2\}$ and $\gamma < g_n$ solutions are smaller that the solution of the equation $p_{n+1}^x - p_n^x = 1$, see Figure 2.

Let:

- (1) $g_A(p) = 2\sqrt{p} + 1$, Andrica's gap function ;
- (2) $g_{CG}(p) = 2 \cdot e^{-\gamma} \cdot \ln(p)^2$, Cramér-Grandville's gap function ;
- (3) $g_F(p) = g_1(p) = \ln(p)^2 - \ln(p)$, Firoozbakht's gap function;
- (4) $g_c(p) = \ln(p)^2 - c \cdot \ln(p)$, where $c = 4(2 \ln(2) - 1) \approx 1.545 \dots$,
- (5) $g_b(p) = \ln(p)^2 - b \cdot \ln(p)$, where $b = 6(2 \ln(2) - 1) \approx 2.318 \dots$.

Theorem 2.8 *The inequality $g_A(p) > g_\alpha(p)$ is true for:*

- (1) $\alpha = 1$ and $p \in \mathbb{P}_{\geq 3} \setminus \{7, 11, \dots, 41\}$;
- (2) $\alpha = c = 4(2 \ln(2) - 1)$ and $p \in \mathbb{P}_{\geq 3}$;
- (3) $\alpha = b = 6(2 \ln(2) - 1)$ and $p \in \mathbb{P}_{\geq 3}$ and the function g_A increases at at a higher rate then function g_b .

Proof Let the function

$$d_\alpha(p) = g_A(p) - g_\alpha(p) = 1 + 2\sqrt{p} + \alpha \cdot \ln(p) - \ln(p)^2$$

The derivative of function d_α is

$$d'_\alpha(p) = \frac{\alpha - 2 \ln(p) + \sqrt{p}}{p}.$$

The analytical solutions for function d'_1 are $5.099 \dots$ and $41.816 \dots$. At the same time, $d'_1(p) < 0$ for $\{7, 11, \dots, 41\}$ and $d'_1(p) > 0$ for $p \in \mathbb{P}_{\geq 3} \setminus \{7, 11, \dots, 41\}$, meaning that the function d_1 is strictly increasing only over $p \in \mathbb{P}_{\geq 3} \setminus \{7, 11, \dots, 41\}$ (see Figure 3).

For $\alpha = c = 4(2 \ln(2) - 1) \approx 1.5451774444795623 \dots$, $d'_c(p) > 0$ for any $p \in \mathbb{P}_{\geq 3}$, (d'_c is nulled for $p = 16$, but $16 \notin \mathbb{P}_{\geq 3}$), then function d_c is strictly increasing for $p \in \mathbb{P}_{\geq 3}$ (see Figure c). Because function d_c is strictly increasing and $d_c(3) = \ln(3)(8 \ln(2) - 4 - \ln(3)) + 2\sqrt{3} + 1 \approx 4.954 \dots$, it follows that $d_c(p) > 0$ for any $p \in \mathbb{P}_{\geq 3}$.

In $\alpha = b = 6(2 \ln(2) - 1) \approx 2.3177661667193434 \dots$, function d_b is increasing fastest for any $p \in \mathbb{P}_{\geq 3}$ (because $d'_b(p) > d'_\alpha(p)$ for any $p \in \mathbb{P}_{\geq 3}$ and $\alpha \geq 0$, $\alpha \neq b$). Since $d'_b(p) > 0$ for any $p \in \mathbb{P}_{\geq 3}$ and because

$$d_b(3) = \ln(3)(12 \ln(2) - 6 - \ln(3)) + 2\sqrt{3} + 1 \approx 5.803479047342222 \dots$$

It follows that $d_b(p) > 0$ for any $p \in \mathbb{P}_{\geq 3}$ (see Figure 3). □

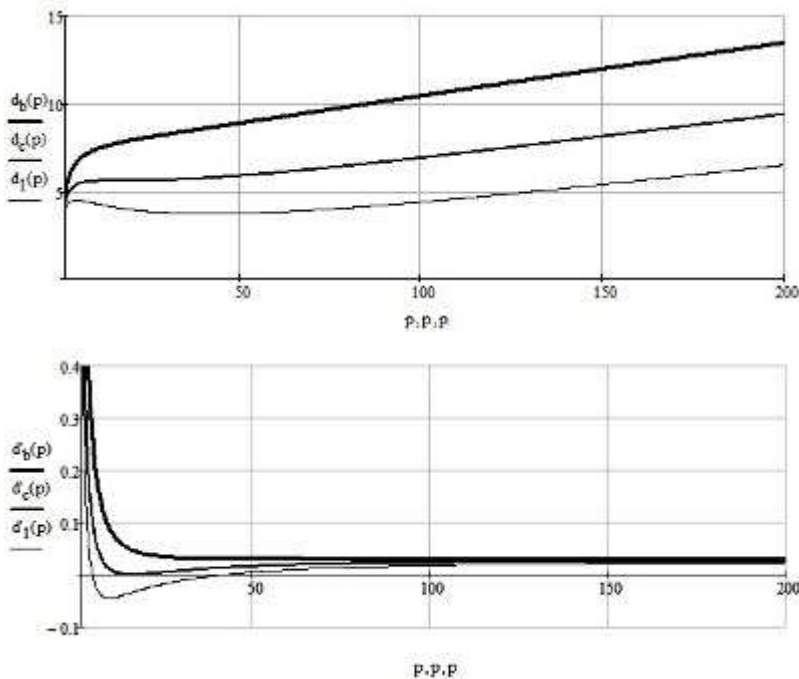

Figure 3 d_α and d'_α functions

Remark 2.9 In order to determine the value of c , we solve the equation $d'_\alpha(p) = 0$ in respect to α . The solution α in respect to p is $\alpha(p) = 2 \ln(p) - \sqrt{p}$. We determine p , the solution of $\alpha'(p) = \frac{4 - \sqrt{p}}{2p}$. Then it follows that $c = \alpha(16) = 4(2 \ln(2) - 1)$.

Remark 2.10 In order to find the value for b , we solve the equation $d''_\alpha(p) = 0$ in respect to α . The solution α in respect to p is $\alpha(p) = 2 \ln(p) - \frac{\sqrt{p}}{2} - 2$. We determine p , the solution of $\alpha'(p) = \frac{8 - \sqrt{p}}{4p}$. It follows that $b = \alpha(8) = 6(2 \ln(2) - 1)$.

Since function d_b manifests the fastest growth rate we can state that the function g_A increases more rapidly then function g_b .

$$\text{Let } h(p, g) = f(0.5) = \sqrt{p+g} - \sqrt{p} - 1 .$$

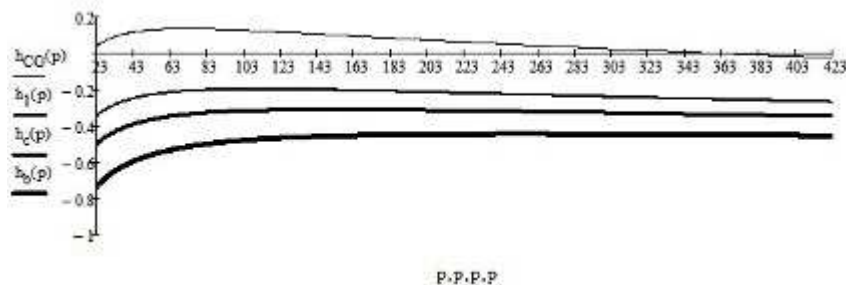

Figure 4 Functions h_b, h_c, h_F and h_{CG}

Theorem 2.11 For

$$h_{CG}(p) = h(p, g_{CG}(p)) = \sqrt{p + 2e^{-\gamma} \ln(p)^2} - \sqrt{p} - 1$$

$h_{CG}(p) < 0$ for $p \in \{3, 5, 7, 11, 13, 17\} \cup \{359, 367, \dots\}$ and

$$\lim_{p \rightarrow \infty} h_{CG}(p) = -1 .$$

Proof The theorem can be proven by direct computation, as observed in the graph from Figure 4. \square

Theorem 2.12 The function

$$h_F(p) = h_1(p) = h(p, g_F(p)) = \sqrt{p + \ln(p)^2 - \ln(p)} - \sqrt{p} - 1$$

reaches its maximal value for $p = 111.152 \dots$ and $h_F(109) = -0.201205 \dots$ while $h_F(113) = -0.201199 \dots$ and

$$\lim_{p \rightarrow \infty} h_F(p) = -1 .$$

Proof Again, the theorem can be proven by direct calculation as one can observe from the graph in Figure 4. \square

Theorem 2.13 The function

$$h_c(p) = h(p, g_c(p)) = \sqrt{p + \ln(p)^2 - c \ln(p)} - \sqrt{p} - 1$$

reaches its maximal value for $p = 152.134 \dots$ and $h_c(151) = -0.3105 \dots$ while $h_c(157) = -0.3105 \dots$ and

$$\lim_{p \rightarrow \infty} h_c(p) = -1 .$$

Proof Again, the theorem can be proven by direct calculation as one can observe from the graph in Figure 4. \square

Theorem 2.14 The function

$$h_B(p) = h(p, g_B(p)) = \sqrt{\ln(p)^2 - b \ln(p) + p} - \sqrt{p} - 1$$

reaches its maximal value for $p = 253.375 \dots$ and $h_B(251) = -0.45017 \dots$ while $h_B(257) = -0.45018 \dots$ and

$$\lim_{p \rightarrow \infty} h_B(p) = -1 .$$

Proof Again, the theorem can be proven by direct calculation as one can observe from the graph in Figure 4. \square

Table 1: Maximal gaps [24, 14, 15]

	#	n	p_n	g_n
1	1	1	2	1
2	2	2	3	2
3	4	4	7	4
4	9	9	23	6
5	24	24	89	8
6	30	30	113	14
7	99	99	523	18
8	154	154	887	20
9	189	189	1129	22
10	217	217	1327	34
11	1183	1183	9551	36
12	1831	1831	15683	44
13	2225	2225	19609	52
14	3385	3385	31397	72
15	14357	14357	155921	86
16	30802	30802	360653	96
17	31545	31545	370261	112
18	40933	40933	492113	114
19	103520	103520	1349533	118
20	104071	104071	1357201	132
21	149689	149689	2010733	148
22	325852	325852	4652353	154
23	1094421	1094421	17051707	180
24	1319945	1319945	20831323	210
25	2850174	2850174	47326693	220
26	6957876	6957876	122164747	222
27	10539432	10539432	189695659	234
28	10655462	10655462	191912783	248
29	20684332	20684332	387096133	250
30	23163298	23163298	436273009	282
31	64955634	64955634	1294268491	288

#	n	p_n	g_n
32	72507380	1453168141	292
33	112228683	2300942549	320
34	182837804	3842610773	336
35	203615628	4302407359	354
36	486570087	10726904659	382
37	910774004	20678048297	384
38	981765347	22367084959	394
39	1094330259	25056082087	456
40	1820471368	42652618343	464
41	5217031687	127976334671	468
42	7322882472	182226896239	474
43	9583057667	241160624143	486
44	11723859927	297501075799	490
45	11945986786	303371455241	500
46	11992433550	304599508537	514
47	16202238656	416608695821	516
48	17883926781	461690510011	532
49	23541455083	614487453523	534
50	28106444830	738832927927	540
51	50070452577	1346294310749	582
52	52302956123	1408695493609	588
53	72178455400	1968188556461	602
54	94906079600	2614941710599	652
55	251265078335	7177162611713	674
56	473258870471	13829048559701	716
57	662221289043	19581334192423	766
58	1411461642343	42842283925351	778
59	2921439731020	90874329411493	804
60	5394763455325	171231342420521	806
61	6822667965940	218209405436543	906
62	35315870460455	1189459969825483	916
63	49573167413483	1686994940955803	924
64	49749629143526	1693182318746371	1132

#	n	p_n	g_n
65	1175661926421598	43841547845541059	1184
66	1475067052906945	55350776431903243	1198
67	2133658100875638	80873624627234849	1220
68	5253374014230870	203986478517455989	1224
69	5605544222945291	218034721194214273	1248
70	7784313111002702	305405826521087869	1272
71	8952449214971382	352521223451364323	1328
72	10160960128667332	401429925999153707	1356
73	10570355884548334	418032645936712127	1370
74	20004097201301079	804212830686677669	1442
75	34952141021660495	1425172824437699411	1476

We denote by $a_n = \lfloor g_A(p_n) \rfloor$ (Andrica's conjecture), by $cg_n = \lfloor g_{CG}(p_n) \rfloor$ (Cramér-Grandville's conjecture) by $f_n = \lfloor g_F(p_n) \rfloor$ (Firoozbakht's conjecture), by $c_n = \lfloor g_c(p_n) \rfloor$ and $b_n = \lfloor g_b(p_n) \rfloor$.

The columns of Table 2 represent the values of the maximal gaps a_n , cg_n , f_n , c_n , b_n and g_n , [14, 2, 28, 15]. Note the Cramér-Grandville's conjecture as well as Firoozbakht's conjecture are confirmed when $n \geq 9$ (for $p_9 = 23$, the forth row in the table of *maximal gaps*).

Table 2: Approximative values of maximal gaps

#	a_n	cg_n	f_n	c_n	b_n	g_n
1	3	0	-1	-1	-2	1
2	4	1	0	-1	-2	2
3	6	4	1	0	-1	4
4	10	11	6	4	2	6
5	19	22	15	13	9	8
6	22	25	17	15	11	14
7	46	43	32	29	24	18
8	60	51	39	35	30	20
9	68	55	42	38	33	22
10	73	58	44	40	35	34
11	196	94	74	69	62	36

#	a_n	cg_n	f_n	c_n	b_n	g_n
12	251	104	83	78	70	44
13	281	109	87	82	74	52
14	355	120	96	91	83	72
15	790	160	131	123	115	86
16	1202	183	150	143	134	96
17	1217	184	151	144	134	112
18	1404	192	158	151	141	114
19	2324	223	185	177	166	118
20	2330	223	185	177	166	132
21	2837	236	196	188	177	148
22	4314	264	220	211	200	154
23	8259	311	260	251	238	180
24	9129	318	267	257	244	210
25	13759	350	294	285	271	220
26	22106	389	328	317	303	222
27	27547	407	344	333	319	234
28	27707	408	344	334	319	248
29	39350	439	371	360	345	250
30	41775	444	375	365	349	282
31	71952	494	419	407	391	288
32	76241	499	423	412	396	292
33	95937	521	443	431	414	320
34	123978	546	464	452	435	336
35	131186	552	469	457	440	354
36	207142	598	510	497	479	382
37	287598	633	540	527	509	384
38	299113	637	544	531	512	394
39	316583	643	549	536	517	456
40	413051	672	574	561	542	464
41	715476	734	628	614	594	468
42	853761	754	646	632	612	474
43	982163	771	660	646	626	486
44	1090874	783	671	657	636	490

#	a_n	cg_n	f_n	c_n	b_n	g_n
45	1101584	784	672	658	637	500
46	1103811	785	672	658	637	514
47	1290905	803	689	674	653	516
48	1358957	810	694	679	659	532
49	1567786	827	709	694	673	534
50	1719108	838	719	704	683	540
51	2320599	875	752	736	715	582
52	2373770	878	754	739	717	588
53	2805843	899	773	757	735	602
54	3234157	918	788	773	751	652
55	5358046	983	846	830	807	674
56	7437486	1028	885	868	845	716
57	8850161	1051	906	889	865	766
58	13090804	1106	953	936	912	778
59	19065606	1159	1000	983	958	804
60	26171079	1206	1041	1023	998	806
61	29543826	1224	1057	1039	1013	906
62	68977097	1353	1170	1151	1124	916
63	82146088	1380	1194	1175	1148	924
64	82296594	1380	1194	1175	1148	1132
65	418767467	1648	1430	1409	1379	1184
66	470534915	1668	1447	1426	1396	1198
67	568765768	1701	1476	1455	1425	1220
68	903297246	1783	1548	1526	1496	1224
69	933883765	1789	1553	1532	1501	1248
70	1105270694	1820	1580	1558	1527	1272
71	1187469955	1833	1592	1570	1538	1328
72	1267169959	1844	1602	1580	1549	1356
73	1293108884	1848	1605	1583	1552	1370
74	1793558286	1908	1658	1636	1604	1442
75	2387612050	1962	1705	1682	1650	1476

Table 2, the graphs in 5 and 6 stand proof that

$$g_n = p_{n+1} - p_n < \ln(p_n)^2 - c \cdot \ln(p_n) , \tag{2.3}$$

for $p \in \{89, 113, \dots, 1425172824437699411\}$. By Theorem 2.6 we can say that inequality (2.3) is true for any $p \in \mathbb{P}_{\geq 89} \setminus \mathbb{P}_{\geq 1425172824437699413}$.

This valid statements in respect to the inequality (2.3) allows us to consider the following hypothesis.

Conjecture 2.1 *The relation (2.3) is true for any $p \in \mathbb{P}_{\geq 29}$.*

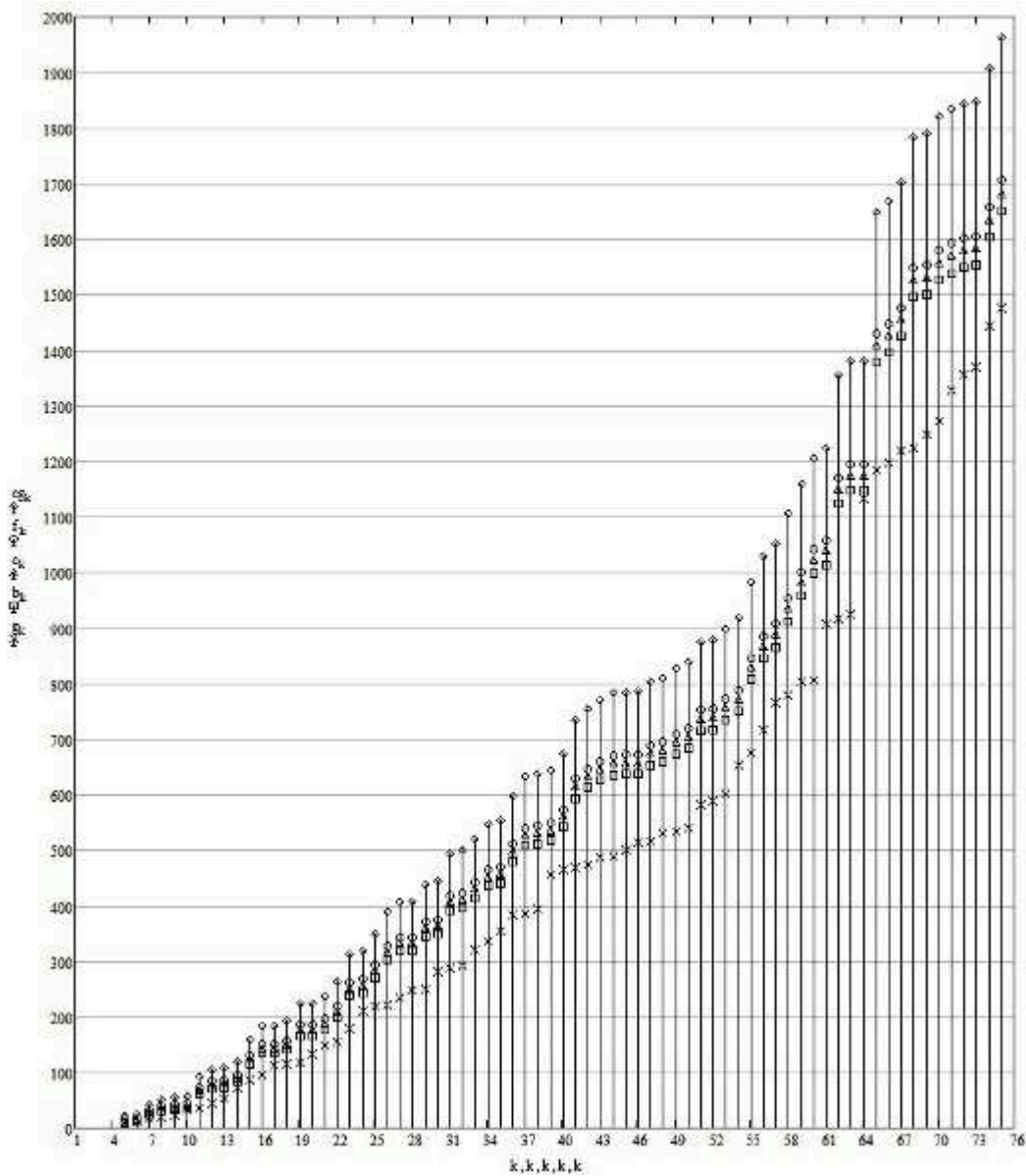

Figure 5 Maximal gaps graph

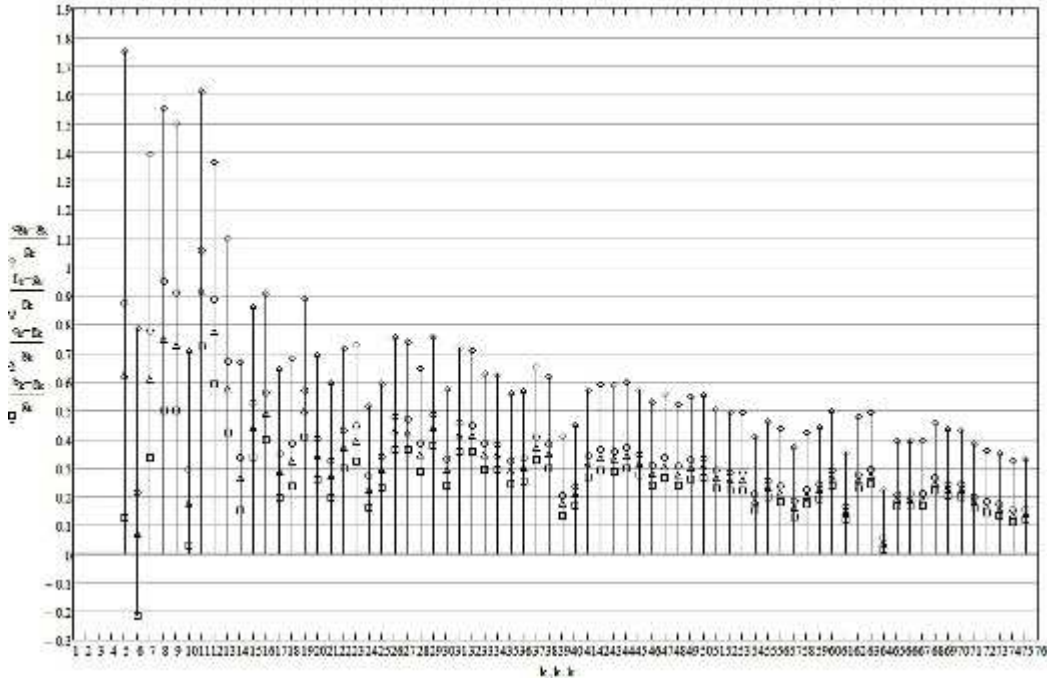

Figure 6 Relative errors of cg , f , c and b in respect to g

Let $g_\alpha : \mathbb{P}_{\geq 3} \rightarrow \mathbb{R}_+$,

$$g_\alpha(p) = \ln(p)^2 - \alpha \cdot \ln(p)$$

and $h_\alpha : \mathbb{P}_{\geq 3} \times [0, 1] \rightarrow \mathbb{R}$, with p fixed,

$$h_\alpha(p, x) = (p + g_\alpha(p))^x - p^x - 1$$

that, according to Theorem 2.1, is strictly increasing and convex over its domain, and according to the Corollary 2.2 has a unique solution over the interval $[0, 1]$.

We solve the following equation, equivalent to (2.2)

$$h_c(p, x) = (p + \ln(p)^2 - c \ln(p))^x - p^x - 1 = 0, \tag{2.4}$$

in respect to x , for any $p \in \mathbb{P}_{\geq 29}$. In accordance to Theorem 2.5 the solution for equation (2.2) is greater then the solution to equation (2.4). Therefore if we prove that the solutions to equation (2.4) are greater then 0.5 then, even more so, the solutions to (2.2) are greater then 0.5 .

For equation $h_\alpha(p, x) = 0$ we consider the secant method, with the initial iterations x_0 and x_1 (see Figure 7). The iteration x_2 is given by

$$x_2 = \frac{x_1 \cdot h_\alpha(p, x_0) - x_0 \cdot h_\alpha(p, x_1)}{h_\alpha(p, x_1) - h_\alpha(p, x_0)}. \tag{2.5}$$

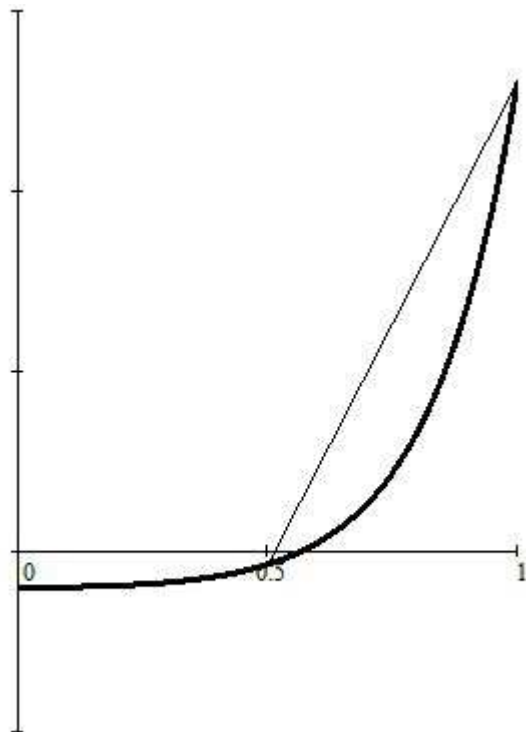

Figure 7 Function f and the secant method

If Andrica's conjecture, $\sqrt{p+g} - \sqrt{p} - 1 < 0$ for any $p \in \mathbb{P}_{\geq 3}$, $g \in \mathbb{N}^*$ and $p > g \geq 2$, is true, then $h_\alpha(p, 0.5) < 0$ (according to Remark 1.1 if Legendre's conjecture is true then Andrica's conjecture is also true), and $h_\alpha(p, 1) > 0$. Since function $h_\alpha(p, \cdot)$ is strictly increasing and convex, iteration x_2 **approximates the solution to the equation** $h_\alpha(p, x) = 0$, (in respect to x). Some simple calculation show that a the solution x_2 in respect to h_α , p , x_0 and x_1 is:

$$a(p, h_\alpha, x_0, x_1) = \frac{x_1 \cdot h_\alpha(p, x_0) - x_0 h_\alpha(p, x_1)}{h_\alpha(p, x_1) - h_\alpha(p, x_0)}. \quad (2.6)$$

Let $a_\alpha(p) = a(p, h_\alpha, 0.5, 1)$, then

$$a_\alpha(p) = \frac{1}{2} + \frac{1 + \sqrt{p} - \sqrt{\ln(p)^2 - \alpha \ln(p) + p}}{2(\ln(p)^2 - \alpha \ln(p) + \sqrt{p} - \sqrt{\ln(p)^2 - \alpha \ln(p) + p})}. \quad (2.7)$$

Theorem 2.15 *The function $a_c(p)$, that approximates the solution to equation (2.4) has values in the open interval $(0.5, 1)$ for any $p \in \mathbb{P}_{\geq 29}$.*

Proof According to Theorem 2.8 for $\alpha = c = 4(2 \ln(2) - 1)$ we have $\ln(p)^2 - c \cdot \ln(p) < 2\sqrt{p} + 1$ for any $p \in \mathbb{P}_{\geq 29}$.

We can rewrite function a_c as

$$a_c(p) = \frac{1}{2} + \frac{1 + \sqrt{p} - \sqrt{p+c}}{2(c + \sqrt{p} - \sqrt{p+c})}.$$

which leads to

$$\frac{1 + \sqrt{p} - \sqrt{p+c}}{2(c + \sqrt{p} - \sqrt{p+c})} > 0 ,$$

it follows that $a_c(p) > \frac{1}{2}$ for $p \in \mathbb{P}_{\geq 3}$ (see Figure 8) and we have

$$\lim_{p \rightarrow \infty} a_c(p) = \frac{1}{2} . \quad \square$$

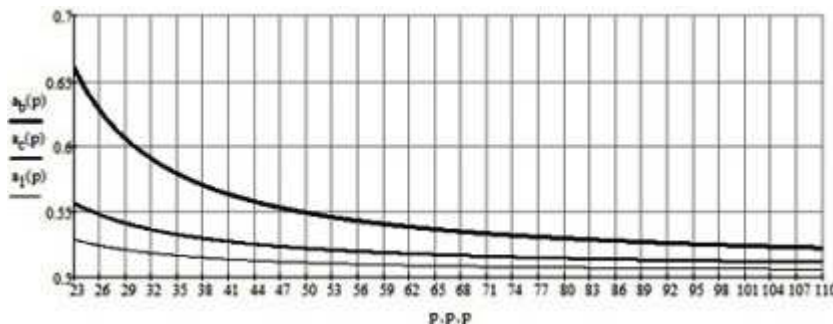

Figure 8 The graphs for functions a_b , a_c and a_1

For $p \in \{2, 3, 5, 7, 11, 13, 17, 19, 23\}$ and the respective gaps we solve the following equations (2.2).

$$\left\{ \begin{array}{l} (2 + 1)^x - 2^x = 1 , \quad s = 1 \\ (3 + 2)^x - 3^x = 1 , \quad s = 0.7271597432435757 \dots \\ (5 + 2)^x - 5^x = 1 , \quad s = 0.7632032096058607 \dots \\ (7 + 4)^x - 7^x = 1 , \quad s = 0.5996694211239202 \dots \\ (11 + 2)^x - 11^x = 1 , \quad s = 0.8071623463868518 \dots \\ (13 + 4)^x - 13^x = 1 , \quad s = 0.6478551304201904 \dots \\ (17 + 2)^x - 17^x = 1 , \quad s = 0.8262031187421179 \dots \\ (19 + 4)^x - 19^x = 1 , \quad s = 0.6740197879899883 \dots \\ (23 + 6)^x - 23^x = 1 , \quad s = 0.6042842019286720 \dots \end{array} \right. \quad (2.8)$$

Corollary 2.9 We proved that the approximative solutions of equation (2.4) are > 0.5 for any $n \geq 10$, then the solutions of equation (2.2) are > 0.5 for any $n \geq 10$. If we consider the exceptional cases (2.8) we can state that the equation (1.1) has solutions in $s \in (0.5, 1]$ for any $n \in \mathbb{N}^*$.

§3. Smarandache Constant

We order the solutions to equation (2.2) in Table 1 using the maximal gaps.

Table 3: Equation (2.2) solutions

p	g	solution for (2.2)
113	14	0.5671481305206224...
1327	34	0.5849080865740931...
7	4	0.5996694211239202...
23	6	0.6042842019286720...
523	18	0.6165497314215637...
1129	22	0.6271418980644412...
887	20	0.6278476315319166...
31397	72	0.6314206007048127...
89	8	0.6397424613256825...
19609	52	0.6446915279533268...
15683	44	0.6525193297681189...
9551	36	0.6551846556887808...
155921	86	0.6619804741301879...
370261	112	0.6639444999972240...
492113	114	0.6692774164975257...
360653	96	0.6741127001176469...
1357201	132	0.6813839139412406...
2010733	148	0.6820613370357171...
1349533	118	0.6884662952427394...
4652353	154	0.6955672852207547...
20831323	210	0.7035651178160084...
17051707	180	0.7088121412466053...
47326693	220	0.7138744163020114...
122164747	222	0.7269826061830018...
3	2	0.7271597432435757...
191912783	248	0.7275969819805509...
189695659	234	0.7302859105830866...
436273009	282	0.7320752818323865...
387096133	250	0.7362578381533295...
1294268491	288	0.7441766589716590...
1453168141	292	0.7448821415605216...

p	g	solution for (2.2)
2300942549	320	0.7460035467176455...
4302407359	354	0.7484690049408947...
3842610773	336	0.7494840618593505...
10726904659	382	0.7547601234459729...
25056082087	456	0.7559861641728429...
42652618343	464	0.7603441937898209...
22367084959	394	0.7606955951728551...
20678048297	384	0.7609716068556747...
127976334671	468	0.7698203623795380...
182226896239	474	0.7723403816143177...
304599508537	514	0.7736363009251175...
241160624143	486	0.7737508697071668...
303371455241	500	0.7745991865337681...
297501075799	490	0.7751693424982924...
461690510011	532	0.7757580339651479...
416608695821	516	0.7760253389165942...
614487453523	534	0.7778809828805762...
1408695493609	588	0.7808871027951452...
1346294310749	582	0.7808983645683428...
2614941710599	652	0.7819658004744228...
1968188556461	602	0.7825687226257725...
7177162611713	674	0.7880214782837229...
13829048559701	716	0.7905146362137986...
19581334192423	766	0.7906829063252424...
42842283925351	778	0.7952277512573828...
90874329411493	804	0.7988558653770882...
218209405436543	906	0.8005126614171458...
171231342420521	806	0.8025304565279002...
1693182318746371	1132	0.8056470803187964...
1189459969825483	916	0.8096231085041140...
1686994940955803	924	0.8112057874892308...
43841547845541060	1184	0.8205327998695296...
55350776431903240	1198	0.8212591131062218...

p	g	solution for (2.2)
80873624627234850	1220	0.8224041089823987...
218034721194214270	1248	0.8258811322716928...
352521223451364350	1328	0.8264955008480679...
1425172824437699300	1476	0.8267652954810718...
305405826521087900	1272	0.8270541728027422...
203986478517456000	1224	0.8271121951019150...
418032645936712100	1370	0.8272229385637846...
401429925999153700	1356	0.8272389079572986...
804212830686677600	1442	0.8288714147741382...
2	1	1

§4 Conclusions

Therefore, if Legendre's conjecture is true then Andrica's conjecture is also true according to Paz [17]. Andrica's conjecture validated the following sequence of inequalities $a_n > cg_n > f_n > c_n > b_n > g_n$ for any n natural number, $5 \leq n \leq 75$, in Tables 2. The inequalities $c_n < g_n$ for any natural n , $5 \leq n \leq 75$, from Table 2 allows us to state Conjecture 2.1.

If Legendre's conjecture and Conjecture 2.1 are true, then Smarandache's conjecture is true.

References

- [1] D.Andrica, Note on a conjecture in prime number theory, *Studia Univ. Babeş- Bolyai Math.*, 31 (1986), no. 4, 44-48.
- [2] C.Caldwell, The prime pages, <http://primes.utm.edu/n0tes/gaps.html>, 2012.
- [3] Ch. K.Caldwell, Lists of small primes, <https://primes.utm.edu/lists/small>, Nov. 2014.
- [4] H. Cramér, On the order of magnitude of the difference between consecutive prime numbers, *Acta Arith.*, 2 (1936), 23-46.
- [5] P. Erdős, Beweis eines Satzes von Tschebyschef, *Acta Scientifica Mathematica*, 5 (1932), 194-198.
- [6] A.Granville, Harald Cramér and the distribution of prime numbers, *Scand. Act. J.*, 1 (1995), 12-28.
- [7] R.K.Guy, *Unsolved Problems in Number Theory*, 2nd ed., p.7, Springer-Verlag, New York, 1994.
- [8] G.H.Hardy and W.M.Wright, *An Introduction to the Theory of Numbers*, 5th ed., Ch.§2.8

- Unsolved Problems Concerning Primes and §3 Appendix*, pp.19 and 415-416, Oxford University Press, Oxford, England, 1979.
- [9] G.Hoheisel, —it Primzahlprobleme in Der Analysis, Sitzungsberichte der Königlich Preussischen Akademie der Wissenschaften zu Berlin 33 (1930), 3-11.
 - [10] E.Landau, *Elementary Number Theory*, Celsea, 1955.
 - [11] A.Loo, On the primes in the interval $[3n, 4n]$, *Int. J. Contemp. Math. Sciences*, 6 (2011), no. 38, 1871-1882.
 - [12] H.Maier, Primes in short intervals, *The Michigan Mathematical Journal*, 32 (1985), No.2, 131-255.
 - [13] P.Mihăilescu, On some conjectures in additive number theory, *Newsletter of the European Mathematical Society*, 1 (2014), No.92, 13-16.
 - [14] T.R.Nicely, New maximal prime gaps and first occurrences, *Mathematics of Computation*, 68 (1999), no. 227, 1311-1315.
 - [15] T.Oliveira e Silva, Gaps between consecutive primes, <http://sweet.ua.pt/tos/gaps.html>, 30 Mach. 2014.
 - [16] H.C.Orsted, G.Forchhammer and J.J.Sm.Steenstrup (eds.), Oversigt over det Kongelige Danske Videnskabernes Selskabs Forhandlinger og dets Medlemmers Arbejder, pp. 169-179, <http://books.google.ro/books?id=UQgXAAAAYAAJ>, 1883.
 - [17] G.A.Paz, On Legendre's, Brocard's, Andrica's and Oppermann's conjectures, arXiv:1310.1323v2 [math.NT], 2 Apr 2014.
 - [18] M.I.Petrescu, A038458, <http://oeis.org>, 3 Oct. 2014.
 - [19] S.Ramanujan, A proof of Bertrand's postulate, *Journal of the Indian Mathematical Society*, 11 (1919), 181-182.
 - [20] P.Ribenboim, *The New Book of Prime Number Records*, 3rd ed., pp.132-134, 206-208 and 397-398, Springer-Verlag, New York, 1996.
 - [21] H.Riesel, *Prime Numbers and Computer Methods for Factorization*, 2nd ed., ch. The Cramér Conjecture, pp. 79-82, MA: Birkhäuser, Boston, 1994.
 - [22] C.Rivera, Conjecture 30. *The Firoozbakht Conjecture*, http://www.primepuzzles.net/conjectures/conj_030.htm, 22 Aug. 2012.
 - [23] C.Rivera, Problems & puzzles: conjecture 007, *The Cramér's conjecture*, http://www.primepuzzles.net/conjectures/conj_007.htm, 03 Oct. 2014.
 - [24] N.J.A.Sloane, *The On-Line Encyclopedia of Integer Sequences*, <http://oeis.org>, 8 Oct. 2014.
 - [25] F.Smarandache, Conjectures which generalize Andrica's conjecture, *Octagon*, 7(1999), No.1, 173-176.
 - [26] E.W.Weisstein, Brocard's conjecture, From *MathWorld* - A Wolfram Web Resource, <http://mathworld.wolfram.com/BrocardsConjecture.html>, 26 Sept. 2014.
 - [27] E.W.Weisstein, Prime counting function, From *MathWorld* - A Wolfram Web Resource, <http://mathworld.wolfram.com/PrimeCountingFunction.html>, 26 Sept. 2014.
 - [28] E.W.Weisstein, Prime gaps, From *MathWorld* - A Wolfram Web Resource, <http://mathworld.wolfram.com/PrimeGaps.html>, 26 Sept. 2014.

- [29] E.W.Weisstein, Smarandache constants, From *MathWorld* - A Wolfram Web Resource, <http://mathworld.wolfram.com/SmarandacheConstants.html>, 26 Sept. 2014.
- [30] E.Westzynthius, Über die Verteilung der Zahlen die zu den n ersten Primzahlen teilerfremd sind, *Commentationes Physico-Mathematicae Helingsfors*, 5 (1931), 1-37.
- [31] M.Wolf, Some heuristics on the gaps between consecutive primes, <http://arxiv.org/pdf/1102.0481.pdf>, 5 May 2011.
- [32] M.Wolf and M.Wolf, First occurrence of a given gap between consecutive primes, 1997.

The Neighborhood Pseudochromatic Number of a Graph

B Sooryanarayana

Dept.of Mathematical and Computational Studies
Dr.Ambedkar Institute of Technology, Bangalore, Pin 560 056, India

Narahari N.

Dept.of Mathematics, University College of Science, Tumkur University, Tumkur, Pin 572 103, India

E-mail: dr_bsnrao@dr-ait.org, hari2102@hotmail.com

Abstract: A *pseudocoloring* of G is a coloring of G in which adjacent vertices can receive the same color. The *neighborhood pseudochromatic number* of a non-trivial connected graph G , denoted $\psi_{nhd}(G)$, is the maximum number of colors used in a pseudocoloring of G such that every vertex has at least two vertices in its closed neighborhood receiving the same color. In this paper, we obtain $\psi_{nhd}(G)$ of some standard graphs and characterize all graphs for which $\psi_{nhd}(G)$ is 1, 2, $n - 1$ or n .

Key Words: Coloring, pseudocoloring, neighborhood, domination.

AMS(2010): 05C15

§1. Introduction

Historically, the coloring terminology comes from the map-coloring problem which involves coloring of the countries in a map in such a way that no two adjacent countries are colored with the same color. The committee scheduling problem is another problem which can be rephrased as a vertex coloring problem. As such, the concept of graph coloring motivates varieties of graph labelings with an addition of various conditions and has a wide range of applications - channel assignment in wireless communications, traffic phasing, fleet maintenance and task assignment to name a few. More applications of graph coloring can be found in [2,17]. A detailed discussion on graph coloring and some of its variations can be seen in [1,5-8,16,18].

Throughout this paper, we consider a graph G which is simple, finite and undirected. A vertex k -coloring of G is a surjection $c : V(G) \rightarrow \{1, 2, \dots, k\}$. A vertex k -coloring c of a graph G is said to be a *proper k -coloring* if vertices of G receive different colors whenever they are adjacent in G . Thus for a proper k -coloring, we have $c(u) \neq c(v)$ whenever $uv \in E(G)$. The minimum k for which there is a proper k -coloring of G is called the chromatic number of G , denoted $\chi(G)$. It can be seen that a proper k -coloring of G is simply a vertex partition of $V(G)$ into k independent subsets called color classes. For any vertex $v \in V(G)$, $N[v] = N(v) \cup \{v\}$

¹Received April 11, 2014, Accepted December 6, 2014.

where $N(v)$ is the set of all the vertices in $V(G)$ which are adjacent to v . As discussed in [14], a dominating set S of a graph $G(V, E)$ is a subset of V such that every vertex in V is either an element of S or is adjacent to an element of S . The minimum cardinality of a dominating set of a graph G is called its dominating number, denoted $\gamma(G)$. Further, a dominating set of G with minimum cardinality is called a γ -set of G .

As introduced in 1967 by Harary et al. [10, 11], a *complete k -coloring* of a graph G is a proper k -coloring of G such that, for any pair of colors, there is at least one edge of G whose end vertices are colored with this pair of colors. The greatest k for which G admits a complete k -coloring is the *achromatic number* $\alpha(G)$. In 1969, while working on the famous Nordaus - Gaddum inequality [16], R. P. Gupta [9] introduced a new coloring parameter, called the *pseudochromatic number*, which generalizes the achromatic number. A pseudo k -coloring of G is a k -coloring in which adjacent vertices may receive same color. A *pseudocomplete k -coloring* of a graph G is a pseudo k -coloring such that, for any pair of distinct colors, there is at least one edge whose end vertices are colored with this pair of colors. The *pseudochromatic number* $\psi(G)$ is the greatest k for which G admits a pseudocomplete k -coloring. This parameter was later studied by V. N. Bhave [3], E. Sampath Kumar [19] and V. Yegnanarayanan [20]. Motivated by the above studies, we introduce here a new graph invariant and study some of its properties in this paper. We use standard notations, the terms not defined here may be found in [4, 12, 14, 15].

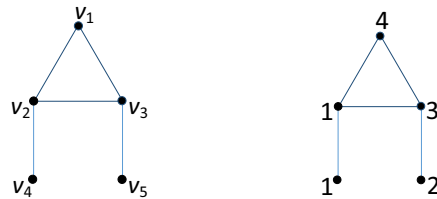

Figure 1. The graph G Figure 2. A pseudo 4-coloring of G

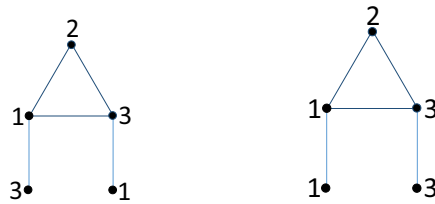

Figure 3. A complete 3-coloring of G Figure 4. A pseudocomplete 3-coloring of G

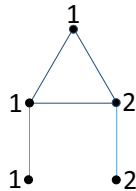

Figure 5. A neighborhood pseudo 2-coloring of G

Definition 1.1 A neighborhood pseudo k -coloring of a connected graph $G(V, E)$ is a pseudo k -coloring $c : V(G) \rightarrow \{1, 2, \dots, k\}$ of G such that for every $v \in V$, $c|_{N[v]}$ is not an injection.

In other words, a connected graph $G = (V, E)$ is said to have a neighborhood pseudo k -coloring if there exists a pseudo k -coloring c of G such that $\forall v \in V(G)$, $\exists u, w \in N[v]$ with $c(u) = c(w)$.

Definition 1.2 The maximum k for which G admits a neighborhood pseudo k -coloring is called the neighborhood pseudochromatic number of G , denoted $\psi_{nhd}(G)$. Further, a coloring c for which k is maximum is called a maximal neighborhood pseudocoloring of G .

The Figures 1-5 show a graph G and its various colorings. The above Definition 1.1 can be extended to disconnected graphs as follows.

Definition 1.3 If G is a disconnected graph with k components H_1, H_2, \dots, H_k , then

$$\psi_{nhd}(G) = \sum_{i=1}^k \psi_{nhd}(H_i).$$

Observation 1.4 For any graph G of order n , $1 \leq \psi_{nhd}(G) \leq n$. In particular, if G is connected, then $1 \leq \psi_{nhd}(G) \leq n - 1$.

Observation 1.5 If H is any connected subgraph of a graph G , then $\psi_{nhd}(H) \leq \psi_{nhd}(G)$.

§2. Preliminary Results

In this section, we study the neighborhood pseudochromatic number of standard graphs. We also obtain certain bounds on the neighborhood pseudochromatic number of a graph. We end the section with a few characterizations. We first state the following theorem whose proof is immediate.

Theorem 2.1 If n is an integer and $n_i \in \mathbb{Z}^+$ for each $i = 1, 2, \dots$,

- (1) $\psi_{nhd}(\overline{K}_n) = n$ for $n \geq 1$;
- (2) $\psi_{nhd}(K_n) = n - 1$ for $n \geq 2$;
- (3) $\psi_{nhd}(P_n) = \lfloor \frac{n}{2} \rfloor$ for $n \geq 2$;
- (4) $\psi_{nhd}(C_n) = \begin{cases} 2 & \text{for } n = 3 \\ \lfloor \frac{n}{2} \rfloor & \text{for } n > 3 \end{cases}$
- (5) $\psi_{nhd}(K_{1,n}) = 1$ for $n \geq 1$;
- (6) $\psi_{nhd}(K_{n_1, n_2, \dots, n_k}) = \sum_{i=1}^k n_i - 2$ where each $n_i \geq 2$.

Corollary 2.2 For any graph G having k components, $\psi_{nhd}(G) \geq k$.

Corollary 2.3 For a connected graph G with diameter d , $\psi_{nhd}(G) \geq \lfloor \frac{d}{2} \rfloor$.

Corollary 2.4 If G is a graph with k non-trivial components H_1, H_2, \dots, H_k and $\omega(H_i)$ is the clique number of H_i , then

$$\psi_{nhd}(G) \geq \sum_{i=1}^k \omega(H_i) - k.$$

Corollary 2.5 $\psi_{nhd}(G) \leq n - k$ for a connected graph G of order $n \geq 3$ with k pendant vertices.

Lemma 2.6 For a connected graph G , $\psi_{nhd}(G) \geq 2$ if and only if G has a subgraph isomorphic to C_3 or P_4 .

Proof If G contains C_3 or P_4 , from Observation 1.5 and Theorem 2.1, $\psi_{nhd}(G) \geq 2$. Conversely, let G be a connected graph with $\psi_{nhd}(G) \geq 2$. If possible, suppose that G has neither a C_3 or nor a P_4 as its subgraph, then G is isomorphic to $K_{1,n}$. But then, $\psi_{nhd}(G) = 1$, a contradiction by Theorem 2.1. \square

As a consequence of Lemma 2.6, we have a consequence following.

Corollary 2.7 A non-trivial graph G is a star if and only if $\psi_{nhd}(G) = 1$.

Theorem 2.8 A graph G of order n is totally disconnected if and only if $\psi_{nhd}(G) = n$.

Proof If a graph G of order n is totally disconnected, then by Theorem 2.1, $\psi_{nhd}(G) = n$. Conversely, if G is not totally disconnected, then G has an edge, say, e . Now for an end vertex of e , at least one color should repeat in G , so $\psi_{nhd}(G) < |V| = n$. Hence the theorem. \square

§3. Characterization of a Graph G with $\psi_{nhd}(G) = n - 1$

Theorem 3.1 For a connected graph G of order n , $\psi_{nhd}(G) = n - 1$ if and only if $G \cong G_1 + P_2$ for some graph G_1 of order $n - 2$.

Proof Let G_1 be any graph on $n - 2$ vertices and $G = G_1 + P_2$. By Observation 1.4, $\psi_{nhd}(G) \leq n - 1$. Now to prove the reverse inequality, let $V(G) = \{v_1, v_2, \dots, v_{n-2}, v_{n-1}, v_n\}$ with v_1, v_2 being the vertices of P_2 . Define a coloring $c : V(G) \rightarrow \{1, 2, \dots, n - 1\}$ as follows:

$$c(v_i) = \begin{cases} 1 & \text{if } i = 1, 2 \\ i - 1 & \text{otherwise} \end{cases}$$

It can be easily seen that c is a neighborhood pseudo k -coloring of G with $k = n - 1$ implies that $\psi_{nhd}(G) \geq n - 1$. Hence $\psi_{nhd}(G) = n - 1$.

Conversely, let $G = (V, E)$ be a connected graph of order n with $\psi_{nhd}(G) = n - 1$. Thus there exists a neighborhood pseudo k -coloring, say c with $k = n - 1$ colors. This implies that all vertices but two in V receive different colors under c . Without loss of generality, let the only two vertices receiving the same color be v_1 and v_2 and other $n - 2$ vertices of G be v_3, v_4, \dots, v_n .

Now, for each i , $3 \leq i \leq n$, we have known that $c|_{N[v_i]}$ is an injection unless both v_1 and v_2 are in $N[v_i]$. Thus each v_i is adjacent to both v_1 and v_2 in G . Further, if v_1 is not adjacent to v_2 , then, as c assigns $n - 1$ colors to the graph $G - \{v_2\}$, we get that $c|_{N[v_1]}$ is an injection from $V(G)$ onto $\{1, 2, \dots, n - 1\}$, which is a contradiction to the fact that c is a neighborhood pseudo $n - 1$ coloring of G . Thus, $G \cong P_2 + G_1$ for some graph G_1 on $n - 2$ vertices. \square

§4. A Bound in Terms of the Domination Number

In this section, we establish a bound on the neighborhood pseudochromatic number of a graph in terms of its domination number. Using this result, we give a characterization of graphs G with $\psi_{nhd}(G) = 2$.

Lemma 4.1 *Every connected graph $G(V, E)$ has a γ -set S satisfying the property that for every $v \in S$, there exists a vertex $u \in V - S$ such that $N(u) \cap S = \{v\}$.*

Proof Consider any γ -set S of a connected graph G . We construct a γ -set with the required property as follows. Firstly, we obtain a γ -set of G with the property that $deg_G(v) \geq 2$ whenever $v \in S$. Let S_1 be the set of all pendant vertices of G in S . If $S_1 = \emptyset$, then S itself is the required set. Otherwise, consider the set $S_2 = (S - S_1) \cup_{v \in S_1} N(v)$. It is easily seen that S_2 is a dominating set. Also, $|S| = |S_2|$ since each vertex of degree 1 in S_1 is replaced by a unique vertex in $V - S$. Otherwise, at least two vertices in S_1 , say u and v , are replaced by a unique vertex in $V - S$, say w , in which case $S' = (S - \{u, v\}) \cup \{w\}$ is a dominating set of G with $|S'| < |S|$, a contradiction to the fact that S is a γ -set. Further, $deg(v) \geq 2$ for all $v \in S_2$ failing which G will not remain connected. In this case, S_2 is the required set. Now, we replace S by S_2 and proceed further.

If for all $v \in S$, there exists $u \in V - S$ such that $N(u) \cap S = \{v\}$, then we are done with the proof. If not, let $D = \{v \in S : N(u) \cap S - \{v\} \neq \emptyset, u \in N(v)\}$. Then, for each vertex v in D , every vertex $u \in N(v)$ is dominated by some vertex $w \in S - \{v\}$. We now claim that w is adjacent to another vertex $x \neq u \in V - S$. Otherwise, $(S - \{v, w\}) \cup \{u\}$ is a dominating set having lesser elements than in S , again a contradiction. Now, replace S by $(S - \{v\}) \cup \{u\}$. Repeating this procedure for every vertex in D will provide a γ -set S of G with the property that for all $v \in S$, there exists $u \in V - S$ such that $N(u) \cap S = \{v\}$. \square

Theorem 4.2 *For any graph G , $\psi_{nhd}(G) \geq \gamma(G)$.*

Proof Let $G = (V, E)$ be a connected graph with $V = \{v_1, v_2, \dots, v_n\}$ with $\gamma(G) = k$. By Lemma 4.1, G has a γ -set, say S , satisfying the property that for all $v \in S$, there exists $u \in V - S$ such that $N(u) \cap S = \{v\}$. Without loss in generality, we take $S = \{v_1, v_2, \dots, v_k\}$, S_1 as the set of all those vertices in $V - S$ which are adjacent to exactly one vertex in S and S_2 as the set of all the remaining vertices in $V - S$ so that $V = S \cup S_1 \cup S_2$.

We define a coloring $c : V(G) \rightarrow \{1, 2, \dots, k\}$ as follows:

$$c(v_i) = \begin{cases} i & \text{if } v_i \in S \\ j & \text{if } v_i \in S_1 \text{ where } j \text{ is the index of the vertex in } S \text{ adjacent to } v_i \\ k & \text{otherwise where } k \text{ is the index of any vertex in } S \text{ adjacent to } v_i \end{cases}$$

Then for every vertex $v_i \in S$, there exists a vertex, say v_j in $V - S$ with $c(v_i) = c(v_j)$ and vice-versa. This ensures that c is a neighborhood pseudocoloring of G . Hence $\psi_{nhd}(G) \geq k = \gamma(G)$. The result obtained for connected graphs can be easily extended to disconnected graphs. \square

§5. Characterization of a Graph G with $\psi_{nhd}(G) = 2$

Using the results in Section 4, we give a characterization of a graph G with pseudochromatic number 2 through the following observation in this section.

Observation 5.1 The following are the six forbidden subgraphs in any non-trivial connected graph G with $\psi_{nhd}(G) \leq 2$, i. e., a non-trivial connected graph G has $\psi_{nhd}(G) \geq 3$ if G has a subgraph isomorphic to one of the six graphs in Figure 6.

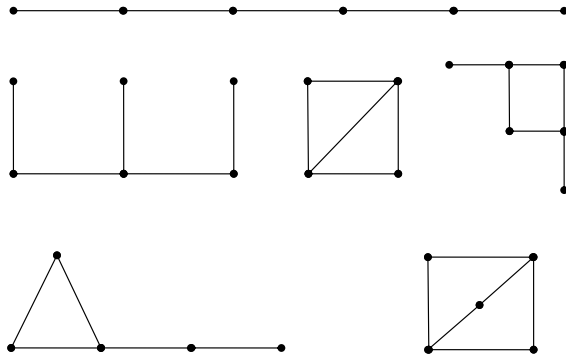

Figure 6. Forbidden subgraphs in a non-trivial connected graph with $\psi_{nhd}(G) \leq 2$

Proof The result follows directly from Observation 1.5 and the fact that the neighborhood pseudochromatic number of each of the graphs in Figure 6 is 3. \square

Theorem 5.2 For a non-trivial connected graph G , $\psi_{nhd}(G) = 2$ if and only if G is isomorphic to one of the three graphs G_1, G_2 or G_3 or is a member of one of the graph families G_4, G_5, G_6, G_7 or G_8 in Figure 7.

Proof Let G be a non-trivial connected graph. Suppose G is isomorphic to one of the three graphs G_1, G_2 or G_3 or is a member of one of the graph families G_4, G_5, G_6, G_7 or G_8 in Figure 7. Then it is easy to observe that $\psi_{nhd}(G) = 2$.

Conversely, suppose $\psi_{nhd}(G) = 2$. By Theorem 4.2, $\gamma(G) \leq \psi_{nhd}(G) = 2$ implies that

either $\gamma(G) = 1$ or $\gamma(G) = 2$.

If $\gamma(G) = 1$, then G is a star $K_{1,n}$, $n \geq 1$ or is isomorphic to G_1 or a member of the family G_4 in Figure 7 or has a subgraph isomorphic to H_3 in Figure 6. Similarly, if $\gamma(G) = 2$, then G is one of the graphs G_2 or G_3 or is a member of the family G_5, G_6, G_7 or G_8 in Figure 7 or has a subgraph isomorphic to one of the graphs in Figure 6.

However, since $\psi_{nhd}(G) = 2$, by Observation 5.1, G cannot have a subgraph isomorphic to any of the graphs in Figure 6. Thus, the only possibility is that G is isomorphic to one of the three graphs G_1, G_2 or G_3 or is a member of one of the graph families G_4, G_5, G_6, G_7 or G_8 in Figure 7. \square

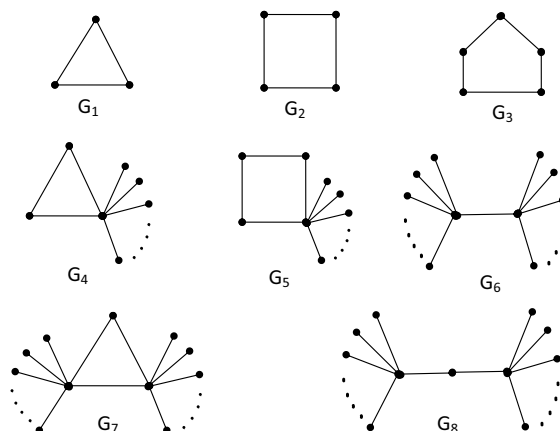

Figure 7. Graphs or graph families with $\psi_{nhd}(G) = 2$

§6. Conclusion

In this paper, we have obtained the neighborhood pseudochromatic number of some standard graphs. We have established some trivial lower bounds on this number. Improving on these lower bounds remains an interesting open problem.

We have also characterized graphs G for which $\psi_{nhd}(G) = 1, 2, n - 1$ or n . However, the problem of characterizing graphs for which $\psi_{nhd}(G) = 3$ still remains open.

Acknowledgment

The authors are indebted to the learned referees for their valuable suggestions and comments. They are thankful to the Principals, Prof. C. Nanjundaswamy, Dr. Ambedkar Institute of Technology and Prof. Eshwar. H. Y, University College of Science, Tumkur University, Tumkur for their constant support and encouragement during the preparation of this paper.

References

- [1] Akiyama J., Harary F. and Ostrand P., A graph and its complement with specified

- properties VI: Chromatic and Achromatic numbers, *Pacific Journal of Mathematics* **104**, No.1(1983), 15-27.
- [2] Bertram E. and Horak P., Some applications of graph theory to other parts of mathematics, *The Mathematical Intelligencer* **21**, Issue 3(1999), 6-11.
- [3] Bhawe V.N., On the pseudoachromatic number of a graph, *Fundamenta Mathematicae*, 102(1979), 159-164.
- [4] Buckley F. and Harary F., *Distance in Graphs*, Addison-Wesley, 1990.
- [5] Gallian J.A., A dynamic survey of graph labeling, *The Electronic Journal of Combinatorics* **18**(2011), DS6.
- [6] Geetha K. N., Meera K. N., Narahari N. and Sooryanarayana B., Open Neighborhood coloring of Graphs, *International Journal of Contemporary Mathematical Sciences* **8**(2013), 675-686.
- [7] Geetha K. N., Meera K. N., Narahari N. and Sooryanarayana B., Open Neighborhood coloring of Prisms, *Journal of Mathematical and Fundamental Sciences* **45A**, No.3(2013), 245-262.
- [8] Griggs J.R. and Yeh R.K., Labeling graphs with a condition at distance 2, *SIAM Journal of Discrete Mathematics* 5(1992), 586-595.
- [9] Gupta R.P., Bounds on the chromatic and achromatic numbers of complementary graphs, *Recent Progress in Combinatorics*, Academic Press, NewYork, 229-235(1969).
- [10] Harary F. and Hedetniemi S. T., The achromatic number of a graph, *J. Combin. Theory* 8(1970), 154-161.
- [11] Harary F., Hedetniemi S.T. and Prins G., An interpolation theorem for graphical homomorphisms, *Portugaliae Mathematica* 26(1967), 453-462.
- [12] Hartsfield G. and Ringel, *Pearls in Graph Theory*, Academic Press, USA, 1994.
- [13] Havet F., *Graph Colouring and Applications*, Project Mascotte, CNRS/INRIA/UNSA, France, 2011.
- [14] Haynes T. W., Hedetniemi S. T. and Slater P.J., *Fundamentals of Domination in Graphs*, Marcel dekker, New York, 1998.
- [15] Jensen T.R. and Toft B., *Graph Coloring Problems*, John Wiley & Sons, New York, 1995.
- [16] Nordhaus E.A. and Gaddum J.W., On complementary graphs, *Amer. Math. Monthly* 63(1956), 175-177.
- [17] Pirzada S. and Dharwadker A., Applications of graph theory, *Journal of the Korean Society for Industrial and Applied Mathematics* 11(2007), 19-38.
- [18] Roberts F.S., From garbage to rainbows: generalizations of graph coloring and their applications, in *Graph Theory, Combinatorics, and Applications*, Y.Alavi, G.Chartrand, O.R. Oellermann and A.J.Schwenk (eds.), 2, 1031- 1052, Wiley, New York, 1991.
- [19] Sampathkumar E. and Bhawe V.N., Partition graphs and coloring numbers of a graph, *Disc. Math.* 16(1976), 57-60.
- [20] Yegnanarayanan V., The pseudoachromatic number of a graph, *Southeast Asian Bull. Math.* 24(2000), 129-136.

Signed Domatic Number of Directed Circulant Graphs

Gunasekaran and A.Devika

(Department of Mathematics, PSG College of Arts and Sciences, Coimbatore, Tamil Nadu, India)

E-mail: gunapsgcas@gmail.com, devirakavi@gmail.com

Abstract: A function $f : V \rightarrow \{-1, 1\}$ is a signed dominating function (SDF) of a directed graph D ([4]) if for every vertex $v \in V$,

$$f(N^-[v]) = \sum_{u \in N^-[v]} f(u) \geq 1.$$

In this paper, we introduce the concept of signed efficient dominating function (SEDF) for directed graphs. A SDF of a directed graph D is said to be SEDF if for every vertex $v \in V$, $f(N^-[v]) = 1$ when $|N^-[v]|$ is odd and $f(N^-[v]) = 2$ when $|N^-[v]|$ is even. We study the signed domatic number $d_S(D)$ of directed graphs. Actually, we give a lower bound for signed domination number $\gamma_S(G)$ and an upper bound for $d_S(G)$. Also we characterize some classes of directed circulant graphs for which $d_S(D) = \delta^-(D) + 1$. Further, we find a necessary and sufficient condition for the existence of SEDF in circulant graphs in terms of covering projection.

Key Words: Signed graphs, signed domination, signed efficient domination, covering projection.

AMS(2010): 05C69

§1. Introduction

Let D be a simple finite digraph with vertex set $V(D) = V$ and arc set $E(D) = E$. For every vertex $v \in V$, in-neighbors of v and out-neighbors of v are defined by $N^-[v] = N_D^-[v] = \{u \in V : (u, v) \in E\}$ and $N^+[v] = N_D^+[v] = \{u \in V : (v, u) \in E\}$ respectively. For a vertex $v \in V$, $d_D^+(v) = d^+(v) = |N^+(v)|$ and $d_D^-(v) = d^-(v) = |N^-(v)|$ respectively denote the outdegree and indegree of the vertex v . The minimum and maximum indegree of D are denoted by $\delta^-(D)$ and $\Delta^-(D)$ respectively. Similarly the minimum and maximum outdegree of D are denoted by $\delta^+(D)$ and $\Delta^+(D)$ respectively.

In [2], J.E. Dunbar et al. introduced the concept of signed domination number of an undirected graph. In 2005, Bohdan Zelinka [1] extended the concept of signed domination in directed graphs.

A function $f : V \rightarrow \{-1, 1\}$ is a signed dominating function (SDF) of a directed graph D

¹Received February 1, 2014, Accepted December 7, 2014.

([4]) if for every vertex $v \in V$,

$$f(N^-[v]) = \sum_{u \in N^-[v]} f(u) \geq 1.$$

The signed domination number, denoted by $\gamma_S(D)$, is the minimum weight of a signed dominating function of D [4]. In this paper, we introduce the concept of signed efficient dominating function (SEDF) for directed graphs. A SDF of a directed graph D is said to be SEDF if for every vertex $v \in V$, $f(N^-[v]) = 1$ when $|N^-[v]|$ is odd and $f(N^-[v]) = 2$ when $|N^-[v]|$ is even.

A set $\{f_1, f_2, \dots, f_d\}$ of signed dominating functions on a graph (directed graph) G with the property that

$$\sum_{i=1}^d f_i(x) \leq 1$$

for each vertex $x \in V(G)$, is called a signed dominating family on G . The maximum number of functions in a signed dominating family on G is the signed domatic number of G , denoted by $d_S(G)$.

The signed domatic number of undirected and simple graphs was introduced by Volkmann and Zelinka [6]. They determined the signed domatic number of complete graphs and complete bipartite graphs. Further, they obtained some bounds for domatic number. They proved the following results.

Theorem 1.1([6]) *Let G be a graph of order $n(G)$ with signed domination number $\gamma_S(G)$ and signed domatic number $d_S(G)$. Then $\gamma_S(G) \cdot d_S(G) \leq n(G)$.*

Theorem 1.1([6]) *Let G be a graph with minimum degree $\delta(G)$, then $1 \leq d_S(G) \leq \delta(G) + 1$.*

In this paper, we study some of the properties of signed domination number and signed domatic number of directed graphs. Also, we study the signed domination number and signed domatic number of directed circulant graphs $Cir(n, A)$. Further, we obtain a necessary and sufficient condition for the existence of SEDF in $Cir(n, A)$ in terms of covering projection.

§2. Signed Domatic Number of Directed Graphs

In this section, we study the signed domatic number of directed graphs. Actually, we give a lower bound for $\gamma_S(G)$ and an upper bound for $d_S(G)$.

Theorem 2.1 *Let D be a directed graph of order n with signed domination number $\gamma_S(D)$ and signed domatic number $d_S(D)$. Then $\gamma_S(D)d_S(D) \leq n$.*

Proof Let $d = d_S(D)$ and $\{f_1, f_2, \dots, f_d\}$ be a corresponding signed dominating family

on D . Then

$$\begin{aligned} d\gamma_S(D) &= \sum_{i=1}^d \gamma_S(D) \leq \sum_{i=1}^d \sum_{v \in V(D)} f_i(v) \\ &= \sum_{v \in V(D)} \sum_{i=1}^d f_i(v) \leq \sum_{v \in V(D)} 1 = n. \end{aligned} \quad \square$$

In [4], H. Karami et al. proved the following result.

Theorem 2.2([4]) *Let D be a digraph of order n in which $d^+(x) = d^-(x) = k$ for each $x \in V$, where k is a nonnegative integer. Then $\gamma_S(D) \geq \frac{n}{k+1}$.*

In the view of Theorems 2.1 and 2.2, we have the following corollary.

Corollary 2.3 *Let D be a digraph of order n in which $d^+(x) = d^-(x) = k$ for each $x \in V$, where k is a nonnegative integer. Then $d_S(D) \leq k+1$.*

The next result is a more general form of the above corollary.

Theorem 2.4 *Let D be a directed graph with minimum in degree $\delta^-(D)$, then $1 \leq d_S(D) \leq \delta^-(D) + 1$.*

Proof Note that the function $f : V(D) \rightarrow \{+1, -1\}$, defined by $f(v) = +1$ for all $v \in V(D)$, is a SDF and $\{f\}$ is a signed domatic family on D . Hence $d_S(D) \geq 1$. Let $d = d_S(D)$ and $\{f_1, f_2, \dots, f_d\}$ be a corresponding signed dominating family of D . Let $v \in V$ be a vertex of minimum degree $\delta^-(D)$.

Then,

$$\begin{aligned} d &= \sum_{i=1}^d 1 \leq \sum_{i=1}^d \sum_{x \in N^-[v]} f_i(x) \\ &= \sum_{x \in N^-[v]} \sum_{i=1}^d f_i(x) \leq \sum_{x \in N^-[v]} 1 = \delta^-(D) + 1. \end{aligned} \quad \square$$

Theorem 2.5([6]) *The signed domination number is an odd integer.*

Remark 2.6 The signed domination number of a directed graph may not be an odd integer. For example, for the directed circulant graph $Cir(10, \{1, 2, 3, 4\})$, the signed domination number is 2.

Theorem 2.7 *Let D be a directed graph such that $d^+(x) = d^-(x) = 2g$ for each $x \in V$ and let $u \in V(D)$. If $d = d_S(D) = 2g + 1$ and $\{f_1, f_2, \dots, f_d\}$ is a signed domatic family of D , then*

$$\sum_{i=1}^d f_i(u) = 1 \quad \text{and} \quad \sum_{x \in N^-[u]} f_i(x) = 1$$

for each $u \in V(D)$ and each $1 \leq i \leq 2g + 1$.

Proof Since $\sum_{i=1}^d f_i(u) \leq 1$, this sum has at least g summands which have the value -1 .

Since $\sum_{x \in N^-[u]} f_i(x) \geq 1$ for each $1 \leq i \leq 2g + 1$, this sum has at least $g + 1$ summands which have the value 1.

Also the sum

$$\sum_{x \in N^-[u]} \sum_{i=1}^d f_i(x) = \sum_{i=1}^d \sum_{x \in N^-[u]} f_i(x)$$

has at least dg summands of value -1 and at least $d(g + 1)$ summands of value 1. Since the sum

$$\sum_{x \in N^-[u]} \sum_{i=1}^d f_i(x) = \sum_{i=1}^d \sum_{x \in N^-[u]} f_i(x)$$

contains exactly $d(2g + 1)$ summands, it is easy to observe that $\sum_{i=1}^d f_i(u)$ have exactly g summands of value -1 and $\sum_{x \in N^-[u]} f_i(x)$ has exactly $g + 1$ summands of value 1 for each $1 \leq i \leq r + 1$.

Hence we must have

$$\sum_{i=1}^d f_i(u) = 1 \quad \text{and} \quad \sum_{x \in N^-[u]} f_i(x) = 1$$

for each $u \in V(D)$ and for each $1 \leq i \leq 2g + 1$. \square

§3. Signed Domatic Number and SEDF in Directed Circulant Graphs

Let Γ be a finite group and e be the identity element of Γ . A generating set of Γ is a subset A such that every element of Γ can be written as a product of finitely many elements of A . Assume that $e \notin A$ and $a \in A$ implies $a^{-1} \in A$. Then the corresponding *Cayley graph* is a graph $G = (V, E)$, where $V(G) = \Gamma$ and $E(G) = \{(x, y)_a \mid x, y \in V(G), y = xa \text{ for some } a \in A\}$, denoted by $Cay(\Gamma, A)$. It may be noted that G is connected regular graph degree of degree $|A|$. A Cayley graph constructed out of a finite cyclic group (\mathbb{Z}_n, \oplus_n) is called a circulant graph and it is denoted by $Cir(n, A)$, where A is a generating set of \mathbb{Z}_n . When we leave the condition that $a \in A$ implies $a^{-1} \in A$, then we get directed circulant graphs. In a directed circulant graph $Cir(n, A)$, for every vertex v , $|N^-[v]| = |N^+[v]| = |A| + 1$.

Throughout this section, $n(\geq 3)$ is a positive integer, $\Gamma = (\mathbb{Z}_n, \oplus_n)$, where $\mathbb{Z}_n = \{0, 1, 2, \dots, n - 1\}$ and $D = Cir(n, A)$, where $A = \{1, 2, \dots, r\}$ and $1 \leq r \leq n - 1$. From here, the operation \oplus_n stands for modulo n addition in \mathbb{Z}_n . In this section, we characterize the circulant graphs for which $d_S(D) = \delta^-(D) + 1$. Also we find a necessary and sufficient condition for the existence of SEDF in $Cir(n, A)$ in terms of covering projection.

Theorem 3.1 *Let $n \geq 3$ and $1 \leq r \leq n - 1$ (r is even) be integers and $D = Cir(n, \{1, 2, \dots, r\})$*

be a directed circulant graph. Then $d_S(D) = r + 1$ if, and only if, $r + 1$ divides n .

Proof Assume that $d_S(D) = r + 1$ and $\{f_1, f_2, \dots, f_{r+1}\}$ is a signed domatic family on D . Since $d^+(v) = d^-(v) = r$, for all $v \in V(D)$, by Theorems 2.1 and 2.2, we have $\gamma_S(D) = \frac{n}{r+1}$.

Suppose n is not a multiple of $r + 1$. Then $n = k(r + 1) + i$ for some $1 \leq i \leq r$. Let $t = \gcd(i, r + 1)$. Then there exist relatively prime integers p and q such that $r + 1 = qt$ and $i = pt$. Let a and b be the smallest integers such that $a(r + 1) = bn$. Then $\gcd(a, b) = 1$; otherwise a and b will not be the smallest.

Now $aqt = a(r + 1) = b(k(r + 1) + i) = b(kqt + pt) = bt(kq + p)$. That is $aq = b(kp + q)$. Note that $\gcd(a, b) = \gcd(p, q) = 1$. Hence $a = kp + q$ and $b = q$. Thus the subgroup $\langle r + 1 \rangle$ of the finite cyclic group \mathbb{Z}_n , generated by $r + 1$, must have $kp + q$ elements. But $t = \frac{r+1}{q} = \frac{n}{kp+q}$. Thus the subgroup $\langle t \rangle$ of \mathbb{Z}_n , generated by the element t , also have $kp + q$ elements and hence $\langle t \rangle = \langle r + 1 \rangle$. Since $d_S(D) = r + 1$ and $\{f_1, f_2, \dots, f_{r+1}\}$ is a signed domatic family of D , by Theorem 2.7, we have

$$\sum_{i=1}^d f_i(u) = 1 \quad \text{and} \quad \sum_{x \in N^-[u]} f_i(x) = 1$$

for each $u \in V(D)$ and each $1 \leq i \leq r + 1$.

From the above fact and since $|N^-[v]| = r + 1$ for all $v \in V(D)$, it follows that if $f(a) = +1$, then $f(a \oplus_n (r + 1)) = +1$ and if $f(a) = -1$, then $f(a \oplus_n (r + 1)) = -1$. Thus all the elements of the subgroup $\langle t \rangle$ have the same sign and hence all the elements in each of the co-set of $\langle t \rangle$ have the same sign. By Lagranges theorem on subgroups, \mathbb{Z}_n can be written as the union of co-sets of $\langle t \rangle = \langle r + 1 \rangle$. This means that $\gamma_S(D)$ must be a multiple of the number of elements of $\langle t \rangle$, that is a multiple of $\frac{n}{t}$ (since n is a multiple of t). Since $t < r + 1$, it follows that $\frac{n}{r+1} < \frac{n}{t} \leq \gamma_S(D)$, a contradiction to $\gamma_S(D) = \frac{n}{r+1}$.

Conversely suppose $r + 1$ divides n . By theorem 2.4, $d_S(D) \leq r + 1$. For each $1 \leq i \leq r + 1$, define $f_i(i) = f_i(i \oplus_{r+1} 1) = \dots = f_i(i \oplus_{r+1} (g - 1)) = -1$ and $f_i(i \oplus_{r+1} g) = \dots = f_i(i \oplus_{r+1} 2g) = +1$, where $g = \frac{n}{2}$, and for the remaining vertices, $f_i(v) = f_i(v \bmod (r + 1))$ for $v \in \{r + 2, r + 3, \dots, n\}$.

Notice that $\{f_1, f_2, \dots, f_{r+1}\}$ are SDFs on D with the property that $\sum_{i=1}^{r+1} f_i(x) \leq 1$ for each vertex $x \in V(D)$. Hence $d_S(D) \geq r + 1$. □

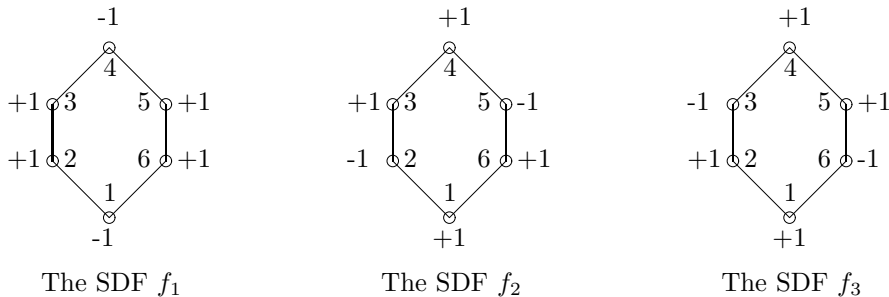

Fig.1

Example 3.2 Let $n = 6$ and $r = 2$. Then n is a multiple of $r + 1$, and $r + 1 = 3$ SDFs f_1 , f_2 and f_3 (as discussed in the above theorem) of $D = Cir(6, \{1, 2\})$ are as given in Fig.1 following, where $V(D) = \{1, 2, 3, 4, 5, 6\}$.

Theorem 3.3 Let $n \geq 3$ be an integer and $1 \leq r \leq n - 1$ be an integer. Let $D = Cir(n, \{1, 2, \dots, r\})$ be a directed circulant graph. If n is a multiple of $r+1$, then $\gamma_S(D) = \frac{n}{r+1}$.

Proof Assume that n is a multiple of $r + 1$. By Theorem 2.2, we have $\gamma_S(D) \geq \frac{n}{r+1}$. It remains to show that there exists a SDF f with the property that $f(D) = \frac{n}{r+1}$.

Define a function f on $V(D)$ by $f(1) = f(2) = \dots = f(g) = -1$ and $f(g+1) = f(g+2) = \dots = f(2g+1) = +1$, where $g = \frac{n}{2}$; and for the remaining vertices, $f(v) = f(v \bmod(r+1))$ for $v \in \{r+2, r+3, \dots, n\}$.

It is clear that f is a SDF and

$$f(D) = (g+1) \left(\frac{n}{r+1} \right) - (g) \left(\frac{n}{r+1} \right) = \frac{n}{r+1}. \quad \square$$

A graph \tilde{G} is called a covering graph of G with covering projection $f : \tilde{G} \rightarrow G$ if there is a surjection $f : V(\tilde{G}) \rightarrow V(G)$ such that $f|_{N(\tilde{v})} : N(\tilde{v}) \rightarrow N(v)$ is a bijection for any vertex $v \in V(G)$ with $\tilde{v} \in f^{-1}(v)$ ([5]).

In 2001, J.Lee has studied the domination parameters through covering projections ([5]). In this paper, we introduce the concept of covering projection for directed graphs and we study the SDF through covering projections.

A directed graph D is called a covering graph of another directed graph H with covering projection $f : D \rightarrow H$ if there is a surjection $f : V(D) \rightarrow V(H)$ such that $f|_{N^+(u)} : N^+(u) \rightarrow N^+(v)$ and $f|_{N^-(u)} : N^-(u) \rightarrow N^-(v)$ are bijections for any vertex $v \in V(H)$ with $u \in f^{-1}(v)$.

Lemma 3.4 Let $f : D \rightarrow H$ be a covering projection from a directed graph D on to another directed graph H . If H has a SEDF, then so is D .

Proof Let $f : D \rightarrow H$ be a covering projection from a directed graph D on to another directed graph H . Assume that H has a SEDF $h : V(H) \rightarrow \{1, -1\}$.

Define a function $g : V(D) \rightarrow \{1, -1\}$ defined by $g(u) = h(f(u))$ for all $u \in V(D)$. Since h is a function from $V(H)$ to $\{1, -1\}$ and $f : V(D) \rightarrow V(H)$, g is well defined. We prove that for the graph D , g is a SEDF.

Firstly, we prove $g(N^-[u]) = 1$ when $u \in V(D)$ and $|N^-[u]|$ is odd. In fact, let $u \in V(D)$ and assume that $|N^-[u]|$ is odd. Since f is a covering projection, $|N^-(u)|$ and $|N^-(f(u))|$ are equal. Also $f|_{N^-(u)} : N^-(u) \rightarrow N^-(f(u))$ is a bijection. Also for each vertex $x \in N^-[u]$, we have $g(x) = h(f(x))$. Since $h(N^-[f(u)]) = 1$, we have $g(N^-[u]) = 1$. Similarly, we can prove that $g(N^-[u]) = -1$ when $u \in V(D)$ and $|N^-[u]|$ is even. Hence g is a SEDF on D . \square

Theorem 3.5 Let $D = Cir(n, \{1, 2, \dots, r\})$, $r = 2g$ and $\gamma_S(D) = \frac{n}{r+1}$. Then D has a SEDF if and only if, there exists a covering projection from D onto the graph $H = Cir(r+1, \{1, 2, \dots, r\})$.

Proof Suppose D has a SEDF f . Then $\sum_{x \in N^-[u]} f(x) = 1$ for all $u \in v(D)$. Thus we can have $f(a \oplus_n r + 1) = \pm 1$ when ever $f(a) = \pm 1$. Thus the elements of the subgroup $\langle r + 1 \rangle$, generated by $r + 1$ have the same sign.

Suppose n is not a multiple of $r + 1$, then $n = i(r + 1) + j$ for some $1 \leq j \leq r$. Let $t = \gcd(r + 1, j)$. Then by Theorem 3.1, we have $\gamma_S(D) > \frac{n}{r+1}$, a contradiction. Hence n must be a multiple of $r + 1$.

In this case, define $F : D \rightarrow H = Cir(r+1, \{1, 2, \dots, r\})$, defined by $F(x) = x \pmod{r+1}$. Note that, $|N^-[x]| = |N^+[x]| = |N^-[y]| = |N^+[y]| = r + 1$ for all $x \in V(D)$ and $y \in V(H)$. We prove that the function F is a covering projection.

Let $x \in V(D)$. Then $F(x) = x \pmod{r+1} = i$ for some $i \in V(H)$ with $1 \leq i \leq r + 1$. Note that by the definition of D and H , $N^+(x) = \{x \oplus_n 1, x \oplus_n 2, \dots, x \oplus_n r\}$ and $N^+(i) = \{i \oplus_{r+1} 1, i \oplus_{r+1} 2, \dots, i \oplus_{r+1} r\}$.

Also, for each $1 \leq g \leq r + 1$, we have $F(x \oplus_n g) = (x \oplus_n g) \pmod{r+1} = (x \oplus_{r+1} g) \pmod{r+1}$ (since n is a multiple of $r + 1$).

Thus $F(x \oplus_n g) = (i \oplus_{r+1} g) \pmod{r+1}$ (since $x \pmod{r+1} = i$). Thus $F|_{N^+(x)} : N^+(x) \rightarrow N^+(F(x))$ is a bijection. Similarly, we can prove that $F|_{N^-(x)} : N^-(x) \rightarrow N^-(F(x))$ is also a bijection and hence F is a covering projection from D onto H .

Conversely, suppose there exists a covering projection F from D onto the graph $H = Cir(r+1, \{1, 2, \dots, r\})$. Define $h : V(H) \rightarrow \{+1, -1\}$ defined by $h(x) = -1$ when $1 \leq x \leq g$ and $h(x) = +1$ when $g + 1 \leq x \leq 2g + 1$. Then h is a SEDF of H and hence by Lemma 3.4, G has a SEDF. \square

Theorem 3.6 *Let $D = Cir(n, \{1, 2, \dots, r\})$, r be an odd integer and $\gamma_S(D) = \frac{n}{r+1}$. Then D has a SEDF if and only if, there exists a covering projection from D onto the graph $H = Cir(r+1, \{1, 2, \dots, r\})$.*

Proof Suppose D has a SEDF f . Let $H = Cir(r+1, \{1, 2, \dots, r\})$. Note that, $|N^-[x]| = |N^+[x]| = |N^-[y]| = |N^+[y]| = r + 1 = 2g$ (say), an even integer, for all $x \in V(D)$ and $y \in V(H)$. Thus

$$\sum_{x \in N^-[u]} f(x) = 2$$

for all $u \in v(D)$. Thus we can have $f(a \oplus_n r + 1) = \pm 1$ when ever $f(a) = \pm 1$. Thus the elements of the subgroup $\langle r + 1 \rangle$, generated by $r + 1$ have the same sign.

Suppose n is not a multiple of $r + 1$, As in the proof of Theorem 3.5, we can get a contradiction. Also the function F defined in Theorem 3.5 is a covering projection from D onto H .

Conversely suppose there exists a covering projection F from D onto the graph $H = Cir(r+1, \{1, 2, \dots, r\})$. Define $h : V(H) \rightarrow \{+1, -1\}$ defined by $h(x) = -1$ when $1 \leq x \leq g - 1$ and $h(x) = +1$ when $g \leq x \leq 2g$. Note that h is a SEDF of H and

$$\sum_{x \in N^-[u]} f(x) = 2$$

for all $u \in v(G)$. Thus by Lemma 3.4, G has a SEDF. \square

References

- [1] Bohdan Zelinka, Signed domination numbers of directed graphs, *Czechoslovak Mathematical Journal*, Vol.55, (2)(2005), 479-482.
- [2] J.E.Dunbar, S.T.Hedetniemi, M.A.Henning and P.J.Slater, Signed domination in graphs, In: *Proc. 7th Internat. conf. Combinatorics, Graph Theory, Applications*, (Y. Alavi, A. J. Schwenk, eds.), John Wiley & Sons, Inc., 1(1995)311-322.
- [3] Haynes T.W., Hedetniemi S.T. & Slater P.J., *Fundamentals of Domination in Graphs*, Marcel Dekker, 2000.
- [4] H.Karami, S.M.Sheikholeslami, Abdollah Khodkar, Lower bounds on the signed domination numbers of directed graphs, *Discrete Mathematics*, 309(2009), 2567-2570.
- [5] J.Lee, Independent perfect domination sets in Cayley graphs, *J. Graph Theory*, Vol.37, 4(2001), 231-219.
- [6] L.Volkman, Signed domatic numbers of the complete bipartite graphs, *Util. Math.*, 68(2005), 71-77.

Neighborhood Total 2-Domination in Graphs

C.Sivagnanam

(Department of General Requirements, College of Applied Sciences - Ibri, Sultanate of Oman)

E-mail: choshi71@gmail.com

Abstract: Let $G = (V, E)$ be a graph without isolated vertices. A set $S \subseteq V$ is called the neighborhood total 2-dominating set (nt2d-set) of a graph G if every vertex in $V - S$ is adjacent to at least two vertices in S and the induced subgraph $\langle N(S) \rangle$ has no isolated vertices. The minimum cardinality of a nt2d-set of G is called the neighborhood total 2-domination number of G and is denoted by $\gamma_{2nt}(G)$. In this paper we initiate a study of this parameter.

Key Words: Neighborhood total domination, neighborhood total 2-domination.

AMS(2010): 05C69

§1. Introduction

The graph $G = (V, E)$ we mean a finite, undirected graph with neither loops nor multiple edges. The order and size of G are denoted by n and m respectively. For graph theoretic terminology we refer to Chartrand and Lesniak [3] and Haynes et.al [5-6].

Let $v \in V$. The open neighborhood and closed neighborhood of v are denoted by $N(v)$ and $N[v] = N(v) \cup \{v\}$ respectively. If $S \subseteq V$ then $N(S) = \bigcup_{v \in S} N(v)$ and $N[S] = N(S) \cup S$.

If $S \subseteq V$ and $u \in S$ then the private neighbor set of u with respect to S is defined by $pn[u, S] = \{v : N[v] \cap S = \{u\}\}$. The chromatic number $\chi(G)$ of a graph G is defined to be the minimum number of colours required to colour all the vertices such that no two adjacent vertices receive the same colour. $H(m_1, m_2, \dots, m_n)$ denotes the graph obtained from the graph H by attaching m_i edges to the vertex $v_i \in V(H)$, $1 \leq i \leq n$. $H(P_{m_1}, P_{m_2}, \dots, P_{m_n})$ is the graph obtained from the graph H by attaching the end vertex of P_{m_i} to the vertex v_i in H , $1 \leq i \leq n$.

A subset S of V is called a dominating set if every vertex in $V - S$ is adjacent to at least one vertex in S . The minimum cardinality of a dominating set is called the domination number of G and is denoted by $\gamma(G)$. Various types of domination have been defined and studied by several authors and more than 75 models of domination are listed in the appendix of Haynes et al., Fink and Jacobson [4] introduced the concept of k -domination in graphs. A dominating set S of G is called a k -dominating set if every vertex in $V - S$ is adjacent to at least k vertices in S . The minimum cardinality of a k -dominating set is called k -domination number of G and is denoted by $\gamma_k(G)$. F. Harary and T.W. Haynes [4] introduced the concept of double

¹Received July 18, 2014, Accepted December 8, 2014.

domination in graphs. A dominating set S of G is called a double dominating set if every vertex in $V - S$ is adjacent to at least two vertices in S and every vertex in S is adjacent to at least one vertex in S . The minimum cardinality of a double dominating set is called double domination number of G and is denoted by $dd(G)$. S. Arumugam and C. Sivagnanam [1], [2] introduced the concept of neighborhood connected domination and neighborhood total domination in graphs. A dominating set S of a connected graph G is called a neighborhood connected dominating set (ncd-set) if the induced subgraph $\langle N(S) \rangle$ is connected. The minimum cardinality of a ncd-set of G is called the neighborhood connected domination number of G and is denoted by $\gamma_{nc}(G)$. A dominating set S of a graph G without isolate vertices is called the neighborhood total dominating set (ntd-set) if the induced subgraph $\langle N(S) \rangle$ has no isolated vertices. The minimum cardinality of a ntd-set of G is called the neighborhood total domination number of G and is denoted by $\gamma_{nt}(G)$. Sivagnanam et.al [8] studied the concept of neighborhood connected 2-domination in graphs. A set $S \subseteq V$ is called a neighborhood connected 2-dominating set (nc2d-set) of a connected graph G if every vertex in $V - S$ is adjacent to at least two vertices in S and the induced subgraph $\langle N(S) \rangle$ is connected. The minimum cardinality of a nc2d-set of G is called the neighborhood connected 2-domination number of G and is denoted by $\gamma_{2nc}(G)$. In this paper we introduce the concept of neighborhood total 2-domination and initiate a study of the corresponding parameter.

Through out this paper we assume the graph G has no isolated vertices.

§2. Neighborhood Total 2-Dominating Sets

Definition 2.1 A set $S \subseteq V$ is called the neighborhood total 2-dominating set (nt2d-set) of a graph G if every vertex in $V - S$ is adjacent to at least two vertices in S and the induced subgraph $\langle N(S) \rangle$ has no isolated vertices. The minimum cardinality of a nt2d-set of G is called the neighborhood total 2-domination number of G and is denoted by $\gamma_{2nt}(G)$.

Remark 2.2 (i) Clearly $\gamma_{2nt}(G) \geq \gamma_{nt}(G) \geq \gamma(G)$, $\gamma_{2nt}(G) \leq \gamma_{2nc}(G)$ and $\gamma_{2nt}(G) \geq \gamma_2(G)$.

(ii) A graph G has $\gamma_{2nt}(G) = 2$ if and only if there exist two vertices $u, v \in V$ such that (a) $\deg u = \deg v = n - 1$ or (b) $\deg u = \deg v = n - 2$, $uv \notin E(G)$ with $G - \{u, v\}$ has no isolated vertices. Thus $\gamma_{2nt}(G) = 2$ if and only if G is isomorphic to either $H + K_2$ for some graph H or $H + \overline{K_2}$ for some graph H with $\delta(H) \geq 1$.

Examples A

- (1) $\gamma_{2nt}(K_n) = 2, n \geq 2$;
- (2) $\gamma_{2nt}(K_{1,n-1}) = n$;
- (3) Let $K_{r,s}$ be a complete bipartite graph and not a star then

$$\gamma_{2nt}(K_{r,s}) = \begin{cases} 3 & r \text{ or } s = 2 \\ 4 & r, s \geq 3 \end{cases}$$

$$(4) \gamma_{2nt}(W_n) = \left\lceil \frac{n}{3} \right\rceil + 1.$$

Theorem 2.3 For any non trivial path P_n ,

$$\gamma_{2nt}(P_n) = \begin{cases} \left\lceil \frac{3n}{5} \right\rceil + 1 & \text{if } n \equiv 0, 3 \pmod{5} \\ \left\lceil \frac{3n}{5} \right\rceil & \text{otherwise} \end{cases}$$

Proof Let $P_n = (v_1, v_2, \dots, v_n)$ and $n = 5k + r$, where $0 \leq r \leq 4$, $S = \{v_i \in V : i = 5j + 1, 5j + 3, 5j + 4, 0 \leq j \leq k\}$ and

$$S_1 = \begin{cases} S & \text{if } n \equiv 1, 4 \pmod{5} \\ S \cup \{v_n\} & \text{if } n \equiv 0, 2 \pmod{5} \\ S \cup \{v_{n-1}\} & \text{if } n \equiv 3 \pmod{5} \end{cases}$$

Clearly S_1 is a nt2d-set of P_n and hence

$$\gamma_{2nt}(P_n) \leq \begin{cases} \left\lceil \frac{3n}{5} \right\rceil + 1 & \text{if } n \equiv 0, 3 \pmod{5} \\ \left\lceil \frac{3n}{5} \right\rceil & \text{otherwise} \end{cases}$$

Let S be any γ_{2nt} -set of P_n . Since any 2-dominating set D of order either $\left\lceil \frac{3n}{5} \right\rceil$, $n \equiv 0, 3 \pmod{5}$ or $\left\lceil \frac{3n}{5} \right\rceil - 1$, $n \equiv 1, 2, 4 \pmod{5}$, $N(D)$ contains isolated vertices, we have

$$|S| \geq \begin{cases} \left\lceil \frac{3n}{5} \right\rceil + 1 & \text{if } n \equiv 0, 3 \pmod{5} \\ \left\lceil \frac{3n}{5} \right\rceil & \text{otherwise} \end{cases}$$

Hence,

$$\gamma_{2nt}(P_n) = \begin{cases} \left\lceil \frac{3n}{5} \right\rceil + 1 & \text{if } n \equiv 0, 3 \pmod{5} \\ \left\lceil \frac{3n}{5} \right\rceil & \text{otherwise.} \end{cases} \quad \square$$

Theorem 2.4 For the cycle C_n on n vertices $\gamma_{2nt}(C_n) = \left\lceil \frac{3n}{5} \right\rceil$.

Proof Let $C_n = (v_1, v_2, \dots, v_n, v_1)$, $n = 5k + r$, where $0 \leq r \leq 4$, $S = \{v_i : i = 5j + 1, 5j + 3, 5j + 4, 0 \leq j \leq k\}$ and

$$S_1 = \begin{cases} S \cup \{v_n\} & \text{if } n \equiv 2 \pmod{5} \\ S & \text{otherwise} \end{cases}$$

Clearly S_1 is a nt2d-set of C_n and hence $\gamma_{2nt}(C_n) \leq \left\lceil \frac{3n}{5} \right\rceil$. Now, let S be any γ_{2nt} -set of C_n . Since any 2-dominating set D of order $\left\lceil \frac{3n}{5} \right\rceil - 1$, $N(D)$ contains isolated vertices, we have

$|S| \geq \lceil \frac{3n}{5} \rceil$. Hence,

$$\gamma_{2nt}(C_n) = \lceil \frac{3n}{5} \rceil. \quad \square$$

We now proceed to obtain a characterization of minimal nt2d-sets.

Lemma 2.5 *A superset of a nt2d-set is a nt2d-set.*

Proof Let S be a nt2d-set of a graph G and let $S_1 = S \cup \{v\}$, where $v \in V - S$. Clearly $v \in N(S)$ and S_1 is a 2-dominating set of G . Suppose there exists an isolated vertex y in $\langle N(S_1) \rangle$. Then $N(y) \subseteq S - N(S)$ and hence y is an isolated vertex in $\langle N(S) \rangle$, which is a contradiction. Hence $\langle N(S_1) \rangle$ has no isolated vertices and S_1 is a nt2d-set. \square

Theorem 2.6 *A nt2d-set S of a graph G is a minimal nt2d-set if and only if for every $u \in S$, one of the following holds.*

- (1) $|N(u) \cap S| \leq 1$;
- (2) *there exists a vertex $v \in (V - S) \cap N(u)$ such that $|N(v) \cap S| = 2$;*
- (3) *there exists a vertex $x \in N(S - \{u\})$ such that $N(x) \cap N(S - \{u\}) = \phi$.*

Proof Let S be a minimal nt2d-set and let $u \in S$. Let $S_1 = S - \{u\}$. Then S_1 is not a nt2d-set. This gives either S_1 is not a 2-dominating set or $\langle N(S_1) \rangle$ has an isolated vertex. If S_1 is not a 2-dominating set then there exists a vertex $v \in V - S_1$ such that $|N(v) \cap S_1| \leq 1$. If $v = u$ then $|N(u) \cap (S - \{u\})| \leq 1$ which gives $|N(u) \cap S| \leq 1$. Suppose $v \neq u$. If $|N(v) \cap S_1| < 1$ then $|N(v) \cap S| \leq 1$ and hence S is not a 2-dominating set which is a contradiction. Hence $|N(v) \cap S_1| = 1$. Thus $v \in N(u)$. So $v \in (V - S) \cap N(u)$ such that $|N(v) \cap S| = 2$. If S_1 is a 2-dominating set and if $x \in N(S_1)$ is an isolated vertex in $\langle N(S_1) \rangle$ then $N(x) \cap N(S_1) = \phi$. Thus $N(x) \cap N(S - \{u\}) = \phi$. Conversely, if S is a nt2d-set of G satisfying the conditions of the theorem, then S is 1-minimal nt2d-set and hence the result follows from Lemma 2.5. \square

Remark 2.7 Any nt2d-set contains all the pendant vertices of the graph.

Remark 2.8 Since any nt2d-set of a spanning subgraph H of a graph G is a nt2d-set of G , we have $\gamma_{2nt}(G) \leq \gamma_{2nt}(H)$.

Remark 2.9 If G is a disconnected graph with k components G_1, G_2, \dots, G_k then $\gamma_{2nt}(G) = \gamma_{2nt}(G_1) + \gamma_{2nt}(G_2) + \dots + \gamma_{2nt}(G_k)$.

Theorem 2.10 *Let G be a connected graph on $n \geq 2$ vertices. Then $\gamma_{2nt}(G) \leq n$ and equality holds if and only if G is a star.*

Proof The inequality is obvious. Let G be a connected graph on n vertices and $\gamma_{2nt}(G) = n$. If $n = 2$ then nothing to prove. Let us assume $n \geq 3$. Suppose G contains a cycle C . Let $x \in V(C)$. Then $V(G) - x$ is a nt2d-set of G , which is a contradiction. Hence G is a tree.

Let u be a vertex such that $deg_u = \Delta$. Let v be a vertex such that $d(u, v) \geq 2$. Let $(u, x_1, x_2, \dots, x_k, v)$, $k \geq 1$ be the shortest $u - v$ path. Then $S_1 = V - \{x_k\}$ is a nt2d-set of G which is a contradiction. Hence $d(u, v) = 1$ for all $v \in V(G)$. Thus G is a star. The converse is

obvious. □

Corollary 2.11 *Let G be a disconnected graph with $\gamma_{2nt}(G) = n$. Then G is a galaxy.*

Theorem 2.12 *Let T be a tree with $n \geq 3$ vertices. Then $\gamma_{2nt}(T) = n - 1$ if and only if T is a bistar $B(n - 3, 1)$ or a tree obtained from a bistar by subdividing the edge of maximum degree once.*

Proof Let u be a support with maximum degree. Suppose there exists a vertex $v \in V(T)$ such that $d(u, v) \geq 4$. Let $(u, x_1, x_2, \dots, x_k, v)$, $k \geq 3$ be the shortest $u - v$ path then $S_1 = V - \{u, x_k\}$ is a nt2d-set of T which is a contradiction. Hence $d(u, v) \leq 3$ for all $v \in V(T)$.

Case 1. $d(u, v) = 3$ for some $v \in V(T)$.

Suppose there exists an vertex $w \in V(T)$, $w \neq v$ such that $d(u, v) = d(u, w) = 3$. Let P_1 be the $u - v$ path and P_2 be the $u - w$ path. Let $P_1 = (u, v_1, v_2, v)$ and $P_2 = (u, w_1, w_2, w)$. If $v_1 \neq w_1$ then $V - \{v_1, w_1\}$ is a nt2d-set of T which is a contradiction. If $v_1 = w_1$ and $v_2 \neq w_2$ then $V - \{v_2, w_2\}$ is a nt2d-set of T which is a contradiction. Hence all the pendant vertices w such that $d(u, w) = 3$ are adjacent to the same support. Let it be x . Let $P = (u, v_1, x)$ be the unique $u - x$ path in T . Let $y \in N(u) - \{v_1\}$. If $\deg y \geq 2$ then $V - \{x, y\}$ is a nt2d-set of T which is a contradiction. Hence T is a tree obtained from a bistar by subdividing the edge of maximum degree once.

Case 2. $d(u, v) \leq 2$ for all $v \in V(T)$.

If $d(u, v) = 1$ for all $v \in V(T)$ and $v \neq u$ then T is a star, which is a contradiction. Hence $d(u, v) = 2$ for some $v \in V(T)$. Suppose there exist two vertices v and w such that $d(u, v) = d(u, w) = 2$. Let P_1 be the $u - v$ path and P_2 be the $u - w$ path. Let $P_1 = (u, v_1, v)$ and $P_2 = (u, w_1, w)$. If $v_1 \neq w_1$ then $V - \{v_1, w_1\}$ is a nt2d-set of T which is a contradiction. If $v_1 = w_1$ then $V - \{u, v_1\}$ is a nt2d-set of T which is a contradiction. Hence exactly one vertex $v \in V$ such that $d(u, v) = 2$. Hence T is isomorphic to $B(n - 3, 1)$. The converse is obvious. □

Theorem 2.13 *Let G be an unicyclic graph. Then $\gamma_{2nt}(G) = n - 1$ if and only if G is isomorphic to C_3 or C_4 or $K_3(n_1, 0, 0)$, $n_1 \geq 1$.*

Proof Let G be an unicyclic graph with cycle $C = (v_1, v_2, \dots, v_r, v_1)$. If $G = C$ then by theorem 2.4, $G = C_3$ or C_4 . Suppose $G \neq C$. Let A be the set of all pendant vertices in G . Clearly A is a subset of any γ_{2nt} -set of G .

Claim 1. Vertices of C of degree more than two or non adjacent.

Let v_i and v_j be the vertices of degree more than two in C . If v_i and v_j are adjacent then $V - \{v_i, v_j\}$ is a nt2d-set of G which is a contradiction. Hence vertices of C of degree more than two or non adjacent.

Claim 2. $d(C, w) = 1$ for all $w \in A$.

Suppose $d(C, w) \geq 2$ for some $w \in A$. Let $(v_1, w_1, w_2, \dots, w_k, w)$ be the unique $v_1 - w$ path in G , $k \geq 1$. Then $V - \{w_1, w_2\}$ is a nt2d-set of G which is a contradiction. Hence $d(C, w) = 1$

for all $w \in A$.

Claim 3. $r = 3$.

Suppose $r \geq 5$. Let $v_1 \in V(C)$ such that $\deg v_1 \geq 3$. Then $V - \{v_1, v_3\}$ is a nt2d-set of G which is a contradiction. If $r = 4$ then $V - \{v_2, v_4\}$ is a nt2d-set of G which is a contradiction. Hence $r = 3$ and G is isomorphic to $K_3(n_1, 0, 0)$, $n_1 \geq 1$. The converse is obvious. \square

Problem 2.14 Characterize the class of graphs for which $\gamma_{2nt}(G) = n - 1$.

Theorem 2.15 Let G be a graph with $\delta(G) \geq 2$ then $\gamma_{2nt}(G) \leq 2\beta_1(G)$.

Proof Let G be a graph with $\delta(G) \geq 2$ and M be a maximum set of independent edges in G . Let S be the vertices in the set of edges of M . Since $V - S$ is an independent set, each $v \in V - S$ must have at least two neighbors in S . Also since S contains no isolated vertices, $\langle N(S) \rangle = G$ and hence $\langle N(S) \rangle$ contains no isolated vertices. Hence S is a nt2d-set of G . Thus $\gamma_{2nt}(G) \leq 2\beta_1(G)$. \square

Problem 2.16 Characterize the class of graphs for which $\gamma_{2nt}(G) = 2\beta_1(G)$.

Notation 2.17 The graph G^* is a graph with the vertex set can be partition into two sets V_1 and V_2 satisfying the following conditions:

- (1) $\langle V_1 \rangle = K_2 \cup \overline{K_s}$;
- (2) $\langle V_2 \rangle$ is totally disconnected;
- (3) $\deg w = 2$ for all $w \in V_2$;
- (4) $\langle V_2 \cup \{u, v\} \rangle$, where $u, v \in V_1$ with $\deg_{\langle V_1 \rangle} u = \deg_{\langle V_1 \rangle} v = 1$, has no isolated vertices.

Theorem 2.18 For any graph G , $\gamma_{2nt}(G) \geq \frac{2n+1-m}{2}$ and the equality holds if and only if G is isomorphic to $B(2, 2)$ or $K_3(1, 1, 0)$ or $K_4 - e$ or $K_2 + \overline{K_{n-2}}$ or G^* .

Proof Let S be a γ_{2nt} -set of G . Then each vertex of $V - S$ is adjacent to at least two vertices in S and since $\langle N(S) \rangle$ has no isolated vertices either $V - S$ or S contains at least one edge. Hence the number of edges $m \geq 2|V - S| + 1 = 2n - 2\gamma_{2nt} + 1$. Then $\gamma_{2nt} \geq \frac{2n+1-m}{2}$.

Let G be a graph with $\gamma_{2nt}(G) = \frac{2n+1-m}{2}$ and let S be the γ_{2nt} - set of G . Suppose $|E(\langle S \rangle \cup \langle V - S \rangle)| \geq 2$. Then $m \geq 2(|V - S|) + 2$ and hence $\gamma_{2nt}(G) \geq \frac{2n+2-m}{2}$ which is a contradiction. Hence either $|E(\langle S \rangle)| = 1$ or $|E(\langle V - S \rangle)| = 1$. Suppose $|E(\langle V - S \rangle)| = 1$ then $|E(\langle S \rangle)| = 0$ and hence $V - S = N(S)$. Since $\langle N(S) \rangle$ has no isolated vertices, $V - S = K_2$. Let $V - S = \{u, v\}$. If $\deg u \geq 3$ or $\deg v \geq 3$ then $m \geq 2(V - S) + 2$. Hence $\gamma_{2nt} \geq \frac{2n+2-m}{2}$ which is a contradiction. Hence $\deg u = 2$ and $\deg v = 2$. Then $|S| \leq 4$. If $|S| = 4$ then G is isomorphic to $B(2, 2)$. If $|S| = 3$ then G is isomorphic to $K_3(1, 1, 0)$. If $|S| = 2$ then G is isomorphic to $K_4 - e$.

Suppose $|E(\langle S \rangle)| = 1$ then $|E(\langle V - S \rangle)| = 0$. Let $|S| = 2$. Since every vertex in $V - S$ is adjacent to both the vertices in S we have G is isomorphic to $K_2 + \overline{K_{n-2}}$. If $|S| \geq 3$ then G is isomorphic to G^* . The converse is obvious. \square

Corollary 2.19 For a tree T , $\gamma_{2nt}(T) \geq \frac{n+2}{2}$.

Problem 2.20 Characterize the class of trees for which $\gamma_{2nt}(T) = \frac{n+2}{2}$.

Theorem 2.21 For any graph G , $\gamma_{2nt}(G) \geq \frac{2n}{\Delta+2}$

Proof Let S be a minimum nt2d-set and let k be the number of edges between S and $V - S$. Since the degree of each vertex in S is at most Δ , $k \leq \Delta\gamma_{2nt}$. But since each vertex in $V - S$ is adjacent to at least 2 vertices in S , $k \geq 2(n - \gamma_{2nt})$ combining these two inequalities produce $\gamma_{2nt}(G) \geq \frac{2n}{\Delta+2}$. \square

Problem 2.22 Characterize the class of graphs for which $\gamma_{2nt}(G) = \frac{2n}{\Delta+2}$.

§3. Neighborhood Total 2-Domination Numbers and Chromatic Numbers

Several authors have studied the problem of obtaining an upper bound for the sum of a domination parameter and a graph theoretic parameter and characterized the corresponding extremal graphs. J. Paulraj Joseph and S. Arumugam [7] proved that $\gamma(G) + \chi(G) \leq n + 1$. They also characterized the class of graphs for which the upper bound is attained. In the following theorems we find an upper bound for the sum of the neighborhood total 2-domination number and chromatic number of a graph, also we characterized the corresponding extremal graphs.

We define the following graphs:

- (1) G_1 is the graph obtained from $K_4 - e$ by attaching a pendant vertex to any one of the vertices of degree two by an edge.
- (2) G_2 is the graph obtained from $K_4 - e$ by attaching a pendant vertex to any one of the vertices of degree three by an edge.
- (3) G_3 is the graph obtained from $(K_4 - e) \cup K_1$ by joining a vertex of degree three, vertex of degree two to the vertex of degree zero by an edge.
- (4) G_4 is the graph obtained from $C_5 + e$ by adding an edge between two non adjacent vertices of degree two.
- (5) G_5 is the graph obtained from K_4 by subdividing an edge once.
- (6) G_6 is the graph obtained from $C_5 + e$ by adding an edge between two non adjacent vertices with one has degree three and another has degree two.
- (7) $G_7 = K_5 - Y_1$ where Y_1 is a maximum matching in K_5 .

Theorem 3.1 For any connected graph G , $\gamma_{2nt}(G) + \chi(G) \leq 2n$ and equality holds if and only if G is isomorphic to K_2 .

Proof The inequality is obvious. Now we assume that $\gamma_{2nt}(G) + \chi(G) = 2n$. This implies $\gamma_{2nt}(G) = n$ and $\chi(G) = n$. Then G is a complete graph and a star. Hence G is isomorphic to K_2 . The converse is obvious. \square

Theorem 3.2 Let G be a connected graph. Then $\gamma_{2nt}(G) + \chi(G) = 2n - 1$ if and only if G is isomorphic to K_3 or P_3 .

Proof Let us assume $\gamma_{2nt}(G) + \chi(G) = 2n - 1$. This is possible only if (i) $\gamma_{2nt}(G) = n$

and $\chi(G) = n - 1$ or (ii) $\gamma_{2nt}(G) = n - 1$ and $\chi(G) = n$. Let $\gamma_{2nt}(G) = n$ and $\chi(G) = n - 1$. Then G is a star and hence $n = 3$. Thus G is isomorphic to P_3 . Suppose (ii) holds. Then G is a complete graph with $\gamma_{2nt}(G) = n - 1$. Then $n = 3$ and hence G is isomorphic to K_3 . The converse is obvious. \square

Theorem 3.3 *For any connected graph G , $\gamma_{2nt}(G) + \chi(G) = 2n - 2$ if and only if G is isomorphic to K_4 or $K_{1,3}$ or $K_3(1, 0, 0)$.*

Proof Let us assume $\gamma_{2nt}(G) + \chi(G) = 2n - 2$. This is possible only if $\gamma_{2nt}(G) = n$ and $\chi(G) = n - 2$ or $\gamma_{2nt}(G) = n - 1$ and $\chi(G) = n - 1$ or $\gamma_{2nt}(G) = n - 2$ and $\chi(G) = n$.

Let $\gamma_{2nt}(G) = n$ and $\chi(G) = n - 2$. Since $\gamma_{2nt}(G) = n$ we have G is a star with $\chi(G) = n - 2$. Hence $n = 4$. Thus G isomorphic to $K_{1,3}$.

Suppose $\gamma_{2nt}(G) = n - 1$ and $\chi(G) = n - 1$. Since $\chi(G) = n - 1$, G contains a complete subgraph K on $n - 1$ vertices. Let $V(K) = \{v_1, v_2, \dots, v_{n-1}\}$ and $V(G) - V(K) = \{v_n\}$. Then v_n is adjacent to v_i for some vertex $v_i \in V(K)$. If $\deg(v_n) = 1$ and $n \geq 4$ then $\{v_i, v_j, v_n\}$, $i \neq j$ is a γ_{2nt} -set of G . Hence $n = 4$ and $K = K_3$. Thus G is isomorphic to $K_3(1, 0, 0)$. If $\deg v_n = 1$ and $n = 3$ then G is isomorphic to P_3 which is a contradiction to $\gamma_{2nt} = n - 1$. If $\deg(v_n) > 1$ then $\gamma_{2nt} = 2$. Then $n = 3$ which gives G is isomorphic to K_3 which is a contradiction to $\chi(G) = n - 1$.

Suppose $\gamma_{2nt}(G) = n - 2$ and $\chi(G) = n$. Since $\chi(G) = n$, G is isomorphic to K_n . But $\gamma_{2nt}(K_n) = 2$ we have $n = 4$. Hence G is isomorphic to K_4 . The converse is obvious. \square

Theorem 3.4 *Let G be a connected graph. Then $\gamma_{2nt}(G) + \chi(G) = 2n - 3$ if and only if G is isomorphic to C_4 or $K_{1,4}$ or P_4 or K_5 or $K_3(2, 0, 0)$ or $K_4(1, 0, 0, 0)$ or $K_4 - e$.*

Proof Let $\gamma_{2nt}(G) + \chi(G) = 2n - 3$. This is possible only if (i) $\gamma_{2nt}(G) = n$, $\chi(G) = n - 3$ or (ii) $\gamma_{2nt}(G) = n - 1$, $\chi(G) = n - 2$ or (iii) $\gamma_{2nt}(G) = n - 2$, $\chi(G) = n - 1$ or (iv) $\gamma_{2nt}(G) = n - 3$, $\chi(G) = n$.

Suppose (i) holds. Then G is a star with $\chi(G) = n - 3$. Then $n = 5$. Hence G is isomorphic to $K_{1,4}$. Suppose (ii) holds. Since $\chi(G) = n - 2$, G is either $C_5 + K_{n-5}$ or G contains a complete subgraph K on $n - 2$ vertices. If $G = C_5 + K_{n-5}$ then $\gamma_{2nt}(G) + \chi(G) \neq 2n - 3$. Thus G contains a complete subgraph K on $n - 2$ vertices. Let $X = V(G) - V(K) = \{v_1, v_2\}$ and $V(G) = \{v_1, v_2, v_3, \dots, v_n\}$.

Case 1. $\langle X \rangle = K_2$.

Since G is connected, without loss of generality we assume v_1 is adjacent to v_3 . If $|N(v_1) \cap N(v_2)| \geq 2$ then $\gamma_{2nt}(G) = 2$ and hence $n = 3$ which is a contradiction. So $|N(v_1) \cap N(v_2)| \leq 1$. Then $\{v_2, v_3, v_4\}$ is a γ_{2nt} -set of G and hence $n = 4$. If $|N(v_1) \cap N(v_2)| = 1$ then G is either $K_4 - e$ or $K_3(1, 0, 0)$. For these graphs $\chi(G) = 3$ which is a contradiction. If $N(v_1) \cap N(v_2) = \phi$. Then G is isomorphic to P_4 or C_4 or $K_3(1, 0, 0)$. Since $\chi[K_3(1, 0, 0)] = 3$, we have G is isomorphic to P_4 or C_4 .

Case 2. $\langle X \rangle = \overline{K_2}$.

Since G is connected v_1 and v_2 are adjacent to at least one vertex in K . If $\deg v_1 =$

$\deg v_2 = 1$ and $N(v_1) \cap N(v_2) \neq \phi$ then $|V(K)| \neq 1$. So $|V(K)| \geq 2$. If $|V(K)| = 2$ then G is isomorphic to $K_{1,3}$ which is a contradiction. Hence $|V(K)| \geq 3$. Then $\{v_1, v_2, v_3, v_4\}$ is a γ_{2nt} -set of G . Hence $n = 5$. Thus G is isomorphic to $K_3(2, 0, 0)$. If $\deg v_1 = \deg v_2 = 1$ and $N(v_1) \cap N(v_2) = \phi$ then $|V(K)| \geq 2$. If $|V(K)| = 2$ then G is isomorphic to P_4 . If $|V(K)| \geq 3$ then $\{v_1, v_2, v_3, v_4\}$ is a γ_{2nt} -set of G . Hence $n = 5$. Thus G is isomorphic to $K_3(1, 1, 0)$. But $\gamma_{2nt}[K_3(1, 1, 0)] = 3$ which is a contradiction. Suppose $\deg v_1 \geq 2$ and $|N(v_1) \cap N(v_2)| \leq 1$ then $\{v_2, v_3, v_4\}$ where $v_3, v_4 \in N(v_1)$ is a γ_{2nt} -set of G . Hence $n = 4$. Then G is isomorphic to $K_3(1, 0, 0)$. For this graph $\gamma_{2nt}(G) = 3$ and $\chi(G) = 3$ which is a contradiction. If $\deg v_1 \geq 2$ and $|N(v_1) \cap N(v_2)| \geq 2$ then $\{v_3, v_4\}$ where $v_3, v_4 \in N(v_1) \cap N(v_2)$ is a γ_{2nt} -set of G . Then $n = 3$ which gives a contradiction.

Suppose (3) holds. Since $\chi(G) = n - 1$, G contains a clique K on $n - 1$ vertices. Let $X = V(G) - V(K) = \{v_1\}$. If $\deg v_1 \geq 2$ then $\gamma_{2nt}(G) = 2$. Hence $n = 4$. Thus G is isomorphic to $K_4 - e$. If $\deg v_1 = 1$ then $|V(K)| \geq 3$ and hence $\{v_1, v_2, v_3\}$ where $v_2 \in N(v_1)$ is a γ_{2nt} -set of G and hence $n = 5$. Thus G is isomorphic to $K_4(1, 0, 0, 0)$.

Suppose (iv) holds. Since $\chi(G) = n$, G is a complete graph. Then $\gamma_{2nt}(G) = 2$ and hence $n = 5$. Therefore G is isomorphic to K_5 . The converse is obvious. \square

Theorem 3.5 *Let G be a connected graph. Then $\gamma_{2nt}(G) + \chi(G) = 2n - 4$ if and only if G is isomorphic to one of the following graphs $P_5, K_6, C_5, K_{1,5}, B(2, 1), K_5(1, 0, 0, 0, 0), K_4(2, 0, 0, 0), K_4(1, 1, 0, 0), K_3(1, 1, 0), K_3(3, 0, 0), C_5 + e, 2K_2 + K_1$ and $K_5 - Y$, where Y is the set of edges incident to a vertex with $|Y| = 1$ or 2 , $G_i, 1 \leq i \leq 7$.*

Proof Let $\gamma_{2nt}(G) + \chi(G) = 2n - 4$. This is possible only if

- (1) $\gamma_{2nt}(G) = n, \chi(G) = n - 4$, or
- (2) $\gamma_{2nt}(G) = n - 1, \chi(G) = n - 3$, or
- (3) $\gamma_{2nt}(G) = n - 2, \chi(G) = n - 2$, or
- (4) $\gamma_{2nt}(G) = n - 3, \chi(G) = n - 1$, or
- (5) $\gamma_{2nt}(G) = n - 4, \chi(G) = n$.

Case 1. $\gamma_{2nt}(G) = n, \chi(G) = n - 4$.

Then G is a star and hence G is isomorphic to $K_{1,5}$.

Case 2. $\gamma_{2nt}(G) = n - 1, \chi(G) = n - 3$.

Since $\chi(G) = n - 3$, G contains a clique K on $n - 3$ vertices. Let $X = V(G) - V(K) = \{v_1, v_2, v_3\}$ and let $V(G) = \{v_1, v_2, \dots, v_n\}$.

Subcase 2.1 $\langle X \rangle = \overline{K_3}$.

Let all v_1, v_2 and v_3 be pendant vertices and $|V(K)| = 1$ then G is a star which is a contradiction. So we assume that v_1, v_2 and v_3 be the pendant vertices and $|V(K)| = 2$. If all v_1, v_2 and v_3 are adjacent to same vertices in K then G is isomorphic to $K_{1,4}$ which is a contradiction. If $N(v_1) \cap N(v_2) = \{v_4\}$ and $N(v_3) = \{v_5\}$ then G is isomorphic to $B(2, 1)$. Let v_1, v_2 and v_3 be the pendant vertices and $|V(K)| = 3$. If all v_1, v_2 and v_3 are adjacent to same vertices in K then G is isomorphic to $K_3(3, 0, 0)$. If $N(v_1) \cap N(v_i) = \phi, i \neq 1$ then $\gamma_{2nt} \neq n - 1$

which is a contradiction. If $|V(K)| \geq 4$ then $\gamma_{2nt} \leq n - 2$ which is a contradiction.

Suppose $\deg v_1 \geq 2$ then $\{v_2, v_3, v_4, v_5\}$ where $v_4, v_5 \in N(v_1)$ is a nt2d-set then $\gamma_{2nt}(G) \leq 4$. Hence $n \leq 5$. Since $\deg v_1 \geq 2$, $n = 5$. Then G contains K_3 and hence $\chi(G) \neq n - 3$ which is a contradiction.

Subcase 2.2 $\langle X \rangle = K_2 \cup K_1$.

Let $v_1v_2 \in E(G)$ and $\deg v_3 = 1$. Suppose $\deg v_2 = 1$ and $\deg v_1 = 2$ and $N(v_1) \cap N(v_3) = \{v_4\}$. If $\deg v_4 = 2$ then G is isomorphic to P_4 and $\gamma_{2nt}(G) + \chi(G) \neq 2n - 4$ which is a contradiction. If $\deg v_4 \geq 3$ then $\{v_2, v_3, v_4, v_5\}$ is γ_{2nt} -set of G . Therefore $n = 5$. Then G is isomorphic to a bistar $B(2, 1)$. If $N(v_1) \cap N(v_3) = \phi$ then K contains at least 2 vertices. If $|V(K)| \geq 3$ then $\gamma_{2nt}(G) = 4$ and hence $n = 5$ which is a contradiction. So $|V(K)| = 2$ and hence G is isomorphic to P_5 .

Suppose $\deg v_3 = 1$, $\deg v_2 = 1$ and $\deg v_1 \geq 3$. Then $\gamma_{2nt}(G) \leq 4$ and hence $n = 5$. This gives $|V(K)| = 2$. Then G is isomorphic to $K_3(1, 1, 0)$ and hence $\gamma_{2nt}(G) = 3$ which is a contradiction.

Suppose $\deg v_1 \geq 3$, $\deg v_2 \geq 2$ and $\deg v_3 = 1$. Then $\gamma_{2nt}(G) \leq 4$ and hence $n = 5$. Then G is isomorphic to the either $K_4(1, 0, 0, 0)$ or a graph obtained from $K_4 - e$ by attaching a pendant vertex to one of the vertices of degree 2. For this graphs $\chi(G) \neq n - 3$ which is a contradiction. If $\deg v_1 \geq 3$, $\deg v_2 \geq 3$ and $\deg v_3 \geq 2$ then $\gamma_{2nt}(G) \leq 4$ and hence $n = 5$. Then G is isomorphic to the graph which is obtained from $K_4 \cup K_1$ by including two edges between a vertex of degree zero and any two vertices of degree three. For this graph $\chi(G) = 4$ which is a contradiction.

Subcase 2.3. $\langle X \rangle = P_3$.

Let $\langle X \rangle = (v_1, v_2, v_3)$. Since G is connected at least one vertex of $\langle X \rangle$ is adjacent to K . Let $N(v_1) \cap V(K) \neq \phi$ and $N(v_i) \cap V(K) = \phi$ for $i = 2, 3$. Let $|N(v_1) \cap V(K)| = 1$ then $\{v_1, v_3, v_4, v_5\}$ is a γ_{2nt} -set of G . Hence $n = 5$. Therefore G is isomorphic to P_5 . If $|N(v_1) \cap V(K)| \geq 2$ then $\gamma_{2nt}(G) \leq 4$. Hence $n = 5$. Then G is isomorphic to $K_3(P_3, P_1, P_1)$. For this graph $\gamma_{2nt}(G) = 3$ which is a contradiction.

Suppose $N(v_2) \cap V(K) \neq \phi$ and $N(v_i) \cap V(K) = \phi$ for $i = 1, 3$. If $|N(v_2) \cap V(K)| = 1$ then G is isomorphic to $B(2, 1)$. If $|N(v_2) \cap V(K)| \geq 2$ then $\gamma_{2nt}(G) = 4$ and hence $n = 5$. Hence G is isomorphic to $K_3(2, 0, 0)$. For this graph $\chi(G) = 3 \neq n - 3$ which is a contradiction. If $|N(v_1) \cap V(K)| \geq 2$, $|N(v_2) \cap V(K)| = 1$ and $N(v_3) \cap V(K) = \phi$ then G is a graph obtained from $K_4 - e$ by attaching a pendant vertex to one of the vertices of degree 2. For this graph $\chi(G) \neq n - 3$ which is a contradiction.

If $|N(v_1) \cap V(K)| \geq 2$ and $|N(v_2) \cap V(K)| \geq 2$ and $N(v_3) \cap V(K) = \phi$ then G is isomorphic to $K_4(1, 0, 0, 0)$. For this graph $\chi(G) = 4$ which is a contradiction. If $|N(v_i) \cap V(K)| \geq 1$ for all $i = 1, 2, 3$ then $\gamma_{2nt}(G) \leq 4$. Hence $n = 5$. Then G is isomorphic to any of the following graphs:

- (i) the graph obtained from $K_4 - e$ by attaching a pendant vertex to any one of the vertices of degree 3;
- (ii) the graph obtained from $K_4 - e$ by subdividing the edge with the end vertices having

degree 3 once;

(iii) $C_5 + e$.

For these graphs either $\gamma_{2nt}(G) \neq n - 1$ or $\chi(G) \neq n - 3$ which is a contradiction.

Subcase 2.4 $\langle X \rangle = K_3$.

Then any two vertices from X and two vertices from $V - X$ form a nt2d-set and hence $\gamma_{2nt}(G) \leq 4$. Then $n \leq 5$. For these graphs $\chi(G) \geq 3$ which is a contradiction.

Case 3. $\gamma_{2nt}(G) = n - 2$ and $\chi(G) = n - 2$.

Since $\chi(G) = n - 2$, G is either $C_5 + K_{n-5}$ or G contains a clique K on $n - 2$ vertices. If $G = C_5 + K_{n-5}$ and $n \geq 6$ then $\gamma_{2nt}(G) + \chi(G) \neq 2n - 4$ which is a contradiction. Hence $n = 5$. Thus $G = C_5$. Let G contains a clique K on $n - 2$ vertices. Let $X = V(G) - V(K) = \{v_1, v_2\}$.

Subcase 3.1 $\langle X \rangle = \overline{K_2}$.

Since G is connected v_1 and v_2 are adjacent to at least one vertex in K . If $\deg v_1 = \deg v_2 = 1$ and $N(v_1) \cap N(v_2) \neq \phi$ then $V(K) = 4$. Hence G is isomorphic to $K_4(2, 0, 0, 0)$. If $\deg v_1 = \deg v_2 = 1$ and $N(v_1) \cap N(v_2) = \phi$ then G is isomorphic to $K_3(1, 1, 0)$ or $K_4(1, 1, 0, 0)$.

Suppose $\deg v_1 \geq 2$ and $|N(v_1) \cap N(v_2)| \leq 1$ then $\{v_2, v_3, v_4\}$ where $v_3, v_4 \in N(v_1)$ is a γ_{2nt} -set of G . Hence $n = 5$. Then G is isomorphic to G_1 or G_2 or G_3 . If $\deg v_1 \geq 2$ and $|N(v_1) \cap N(v_2)| \geq 2$ then $\gamma_{2nt}(G) = 2$. Hence $n = 4$ with $\chi(G) = 3$ which is a contradiction.

Subcase 3.2 $\langle X \rangle = K_2$.

Since G is connected, without loss of generality we assume v_1 is adjacent to v_3 . If $|N(v_1) \cap N(v_2)| \geq 2$ then $\gamma_{2nt}(G) = 2$ and hence $n = 4$. Thus G is K_4 which is a contradiction. So $|N(v_1) \cap N(v_2)| \leq 1$. Then $\{v_2, v_3, v_4\}$ is a γ_{2nt} -set of G and hence $n = 5$. If $\deg v_2 = 1$ then G is isomorphic to $K_3(P_3, P_1, P_1)$ or the graph obtained from $K_4 - e$ by attaching a pendant vertex to any one of the vertices of degree 2. If $\deg(v_2) \geq 2$ then G is isomorphic to $C_5 + e$ or $2K_2 + K_1$ or G_4 or G_5 or G_6 or G_7 .

Case 4. $\gamma_{2nt}(G) = n - 3$ and $\chi(G) = n - 1$.

Then G contains a clique K on $n - 1$ vertices. Let $X = V(G) - V(K) = \{v_1\}$. If $\deg v_1 \geq 2$ then $\gamma_{2nt}(G) = 2$. Hence $n = 5$. Thus G is isomorphic to $K_5 - Y$ where Y is the set of edges incident to a vertex with $|Y| = 1$ or 2 . If $\deg v_1 = 1$ then $\{v_1, v_2, v_3\}$ be the γ_{2nt} -set of G . Hence $n = 6$. Thus G is isomorphic to $K_5(1, 0, 0, 0, 0)$.

Case 5. $\gamma_{2nt}(G) = n - 4$ and $\chi(G) = n$

Then G is a complete graph. Hence $n = 6$. Therefore G is isomorphic to K_6 . The converse is obvious. \square

References

- [1] S. Arumugam and C. Sivagnanam, Neighborhood connected domination in graphs, *J. Combin. Math. Combin. Comput.*, **73**(2010), 55-64.

- [2] S. Arumugam and C. Sivagnanam, Neighborhood total domination in graphs, *Opuscula Mathematica*, **31(4)**(2011), 519-531.
- [3] G. Chartrand and L. Lesniak, *Graphs and Digraphs*, CRC, (2005).
- [4] F. Harary and T.W. Haynes, Double domination in graphs, *Ars Combin.*, **55**(2000), 201-213.
- [5] T.W. Haynes, S.T. Hedetniemi and P.J. Slater, *Fundamentals of Domination in Graphs*, Marcel Dekker, Inc., New York, (1997).
- [6] T.W. Haynes, S.T. Hedetniemi and P.J. Slater, *Domination in Graphs-Advanced Topics*, Marcel Dekker, Inc., New York, (1997).
- [7] J. Paulraj Joseph and S. Arumugam, Domination and colouring in graphs, *International Journal of Management and Systems*, **15** (1999), 37-44.
- [8] C. Sivagnanam, M.P.Kulandaivel and P.Selvaraju Neighborhood Connected 2-domination in graphs, *International Mathematical Forum*, **7(40)**(2012), 1965-1974.

Smarandache Lattice and Pseudo Complement

N.Kannappa

(Mathematics Department, TBML College, Porayar, Tamil Nadu, India)

K.Suresh

(Department of Mathematics, Mailam Engineering College, Vilupuram, Tamil Nadu, India)

E-mail: Porayar.sivaguru91@yahoo.com, Mailam.suya24su02@gmail.com

Abstract: In this paper, we introduce Smarandache - 2-algebraic structure of lattice S , namely *Smarandache lattices*. A Smarandache 2-algebraic structure on a set N means a weak algebraic structure A_0 on N such that there exists a proper subset M of N which is embedded with a stronger algebraic structure A_1 , where a stronger algebraic structure means such a structure which satisfies more axioms, by proper subset one can understand a subset different from the empty set, by the unit element if any, and from the whole set. We obtain some of its characterization through pseudo complemented.

Key Words: Lattice, Boolean algebra, Smarandache lattice and Pseudo complemented lattice.

AMS(2010): 53C78

§1. Introduction

New notions are introduced in algebra to study more about the congruence in number theory by Florentin Smarandache [1]. By <proper subset> of a set A , we consider a set P included in A , different from A , also different from the empty set and from the unit element in A - if any they rank the algebraic structures using an order relationship.

The algebraic structures $S_1 \ll S_2$ if both of them are defined on the same set; all S_1 laws are also S_2 laws; all axioms of S_1 law are accomplished by the corresponding S_2 law; S_2 law strictly accomplishes more axioms than S_1 laws, or in other words S_2 laws has more laws than S_1 . For example, a semi-group \ll monoid \ll group \ll ring \ll field, or a semi group \ll commutative semi group, ring \ll unitary ring, \dots etc. They define a general special structure to be a structure SM on a set A, different from a structure SN, such that a proper subset of A is an SN structure, where SM \ll SN.

§2. Preliminaries

Definition 2.1 Let P be a lattice with 0 and $x \in P$. We say x^* is a pseudo complemented of

¹Received September 1, 2014, Accepted December 10, 2014.

x iff $x^* \in P$ and $x \wedge x^* = 0$, and for every $y \in P$, if $x \wedge y = 0$ then $y \leq x^*$.

Definition 2.2 Let P be a pseudo complemented lattice. $N_P = \{x^* : x \in P\}$ is the set of complements in P . $N_P = \{N_P, \leq_N, \neg_N, 0_N, 1_N, \wedge_N, \vee_N\}$, where

- (1) \leq_N is defined by: for every $x, y \in N_P$, $x \leq_N y$ iff $x \leq_P y$;
- (2) \neg_N is defined by: for every $x \in N_P$, $\neg_N(x) = x^*$;
- (3) \wedge_N is defined by: for every $x, y \in N_P$, $x \wedge_N y = x \wedge_P y$;
- (4) \vee_N is defined by: for every $x, y \in N_P$, $x \vee_N y = (x^* \wedge_P y^*)^*$;
- (5) $1_N = 0_P^*$, $0_N = 0_P$.

Definition 2.3 Let P be a lattice with 0 . Define I_P to be the set of all ideals in P , i.e., $I_P = \langle I_P, \leq_I, \wedge_I, \vee_I, 0_I, 1_I \rangle$, where

$$\leq = \subseteq, i \wedge_I j = I \cap J, i \vee_I j = (I \cup J], 0_I = 0_A, 1_I = A.$$

Definition 2.4 If P is a distributive lattice with 0 , I_P is a complete pseudo complemented lattice, let P be a lattice with 0 and NI_P , the set of normal ideals in P , is given by $NI_P = \{I^* \in I_P : I \in I_P\}$. Alternatively, $NI_P = \{I \in I_P : I = I^{**}\}$. Thus $NI_P = \{NI_P, \subseteq, \cap, \cup, \wedge_{NI}, \vee_{NI}\}$, which is the set of pseudo complements in I_P .

Definition 2.5 A Pseudo complemented distributive lattice P is called a stone lattice if, for all $a \in P$, it satisfies the property $a^* \vee a^{**} = 1$.

Definition 2.6 Let P be a pseudo complemented distributive lattice. Then for any filter F of P , define the set $\delta(F)$ by $\delta(F) = \{a^* \in P / a^* \in F\}$.

Definition 2.7 Let P be a pseudo complemented distributive lattice. An ideal I of P is called a δ -ideal if $I = \delta(F)$ for some filter F of P .

Now we have introduced a definition by [4]:

Definition 2.8 A lattice S is said to be a Smarandache lattice if there exist a proper subset L of S , which is a Boolean algebra with respect to the same induced operations of S .

§3. Characterizations

Theorem 3.1 Let S be a lattice. If there exist a proper subset N_P of S defined in Definition 2.2, then S is a Smarandache lattice.

Proof By hypothesis, let S be a lattice and whose proper subset $N_P = \{x^* : x \in P\}$ is the set of all pseudo complements in P . By definition, if P is a pseudo complement lattice, then $N_P = \{x^* : x \in P\}$ is the set of complements in P , i.e., $N_P = \{N_P, \leq_N, \neg_N, 0_N, 1_N, \wedge_N, \vee_N\}$, where

- (1) \leq_N is defined for every $x, y \in N_P$, $x \leq_N y$ iff $x \leq_P b$;
- (2) $\neg N$ is defined for every $x \in N_P$, $\neg N(x) = x^*$;
- (3) \wedge_N is defined for every $x, y \in N_P$, $x \wedge_N y = x \wedge_P y$;
- (4) \vee_N is defined for every $x, y \in N_P$, $x \vee_N y = (x * \wedge_P y^*)^*$;
- (5) $1_N = 0_{P^*}$, $0_N = 0_P$.

It is enough to prove that N_P is a Boolean algebra.

(1) For every $x, y \in N_P$, $x \wedge_N y \in N_P$ and \wedge_N is meet under \leq_N . If $x, y \in N_P$, then $x = x^{**}$ and $y = y^{**}$.

Since $x \wedge_P y \leq_P x$, by result if $x \leq_N y$ then $y^* \leq_N x^*$, $x^* \leq_P (x \wedge_P y)^*$, and with by result if $x \leq_N y$ then $y^* \leq_N x^*$, $(x \wedge_P y)^{**} \leq_P x$. Similarly, $(x \wedge_P y)^{**} \leq_P y$. Hence $(x \wedge_P y)^{**} \leq_P (x \wedge_P y)^{**}$.

By result, $x \leq_N x^{**}$, $(x \wedge_P y) \leq_P (x \wedge_P y)^{**}$. Hence $(x \wedge_P y) \in N_P$, $(x \wedge_N y) \in N_P$. If $a \in N_P$ and $a \leq_N x$ and $a \leq_N y$, then $a \leq_P x$ and $a \leq_P y$, $a \leq_P (x \wedge_P y)$. Hence $a \leq_N (x \wedge_N y)$. So, indeed \wedge_N is meet in \leq_N .

(2) For every $x, y \in N_P$, $x \vee_N y \in N_P$ and \vee_N is join under \leq_N . Let $x, y \in N_P$. Then $x^*, y^* \in N_P$. By (1), $(x * \wedge_P y^*) \in N_P$. Hence $(x * \wedge_P y^*)^* \in N_P$, and hence $(x \vee_N y) \in N_P$, $(x * \wedge_P y^*) \leq_P x^*$. By result $x \leq_N x^{**}$, $x^{**} \leq_P (x * \wedge_P y^*)^*$ and $N_P = \{x \in P; x = x^{**}\}$, $x \leq_P (x * \wedge_P y^*)^*$.

Similarly, $y \leq_P (x * \wedge_P y^*)^*$. If $a \in N_P$ and $x \leq_N a$ and $y \leq_N a$, then $x \leq_P a$ and $y \leq_P a$, then by result if $x \leq_N y$, then $y^* \leq_N x^*$, $a^* \leq_P x^*$ and $a^* \leq_P y^*$. Hence $a^* \leq_P (x * \wedge_P y^*)^*$. By result if $x \leq_N y$ then $y^* \leq_N x^*$, $(x * \wedge_P y^*)^* \leq_P a^{**}$. Thus, by result $N_P = \{x \in P : x = x^{**}\}$, $(x * \wedge_P y^*)^* \leq_P x$ and $x \vee_N y \leq_N a$. So, indeed \vee_N is join in \leq_N .

(3) $0_N, 1_N \in N_P$ and $0_N, 1_N$ are the bounds of N_P . Obviously $1_N \in N_P$ since $1_N = 0_{P^*}$ and for every $a \in N_P$, $a \wedge_P 0_P = 0_P$. For every $a \in N_P$, $a \leq_P 0_{P^*}$. Hence $a \leq_N 1_N$, $0_{P^*}, 0_P^{**} \in N_P$ and $0_P^* \wedge_P 0_P^{**} \in N_P$. But of course, $0_{P^*} \wedge_P 0_P^{**} = 0_P$. Thus, $0_P \in N_P$, $0_N \in N_P$. Obviously, for every $a \in N_P$, $0_P \leq_P a$. Hence for every $a \in N_P$, $0_N \leq_N a$. So N_P is bounded lattice.

(4) For every $a \in N_P$, $\neg N(a) \in N_P$ and for every $a \in N_P$, $a \wedge_N \neg N(a) = 0_N$, and for every $a \in N_P$, $a \vee_N \neg N(a) = 1_N$.

Let $a \in N_P$. Obviously, $\neg N(a) \in N_P$, $a \vee_N \neg N(a) = a \vee_N a^* = ((a * \wedge_P b^{**})^* = (a * \wedge_P a)^* = 0_{P^*} = 1_N$, $a \wedge_N \neg N(a) = a \wedge_P a^* = 0_P = 0_N$. So N_P is a bounded complemented lattice.

(5) Since $x \leq_N (x \vee_N (y \wedge_N z))$, $(x \wedge_N z) \leq_N x \vee_N (y \wedge_N z)$. Also $(y \wedge_N z) \leq_N x \vee_N (y \wedge_N z)$. Obviously, if $a \leq_N b$, then $a \wedge_N b^* = 0_N$. Since $b \wedge b^* = 0_N$, so $(x \wedge_N z) \wedge_N (x \vee_N (y \wedge_N z))^* = 0_N$ and $(y \wedge_N z) \wedge_N (x \vee_N (y \wedge_N z))^* = 0_N$, $x \wedge_N (z \wedge_N (x \vee_N (y \wedge_N z))^*) = 0_N$, $y \wedge_N (z \wedge_N (x \vee_N (y \wedge_N z))^*) = 0_N$.

By definition of pseudo complement: $z \wedge_N (x \vee_N (y \wedge_N z))^* \leq_N x^*$, $z \wedge_N (x \vee_N (y \wedge_N z))^* \leq_N y^*$, Hence, $z \wedge_N (x \vee_N (y \wedge_N z))^* \leq_N x^* \wedge_N y^*$. Once again, If $a \leq_N b$, then $a \wedge_N b^* = 0_N$. Thus, $z \wedge_N (x \vee_N (y \wedge_N z))^* \wedge (x^* \wedge_N y^*)^* = 0_N$, $z \wedge_N (x^* \wedge_N y^*)^* \leq_N (x \vee_N (y \wedge_N z))^{**}$. Now, by definition of \wedge_N : $z \wedge_N (x^* \vee_N y^*)^* = z \wedge_N (x \vee_N y)$ and by $N_P = \{x \in P : x = x^{**}\}$: $(x \vee_N (y \wedge_N z))^{**} = x \vee_N (y \wedge_N z)$. Hence, $z \wedge_N (x \vee_N y) \leq_N x \vee_N (y \wedge_N z)$.

Hence, indeed N_P is a Boolean Algebra. Therefore by definition, S is a Smarandache lattice. \square

For example, a distributive lattice D_3 is shown in Fig.1,

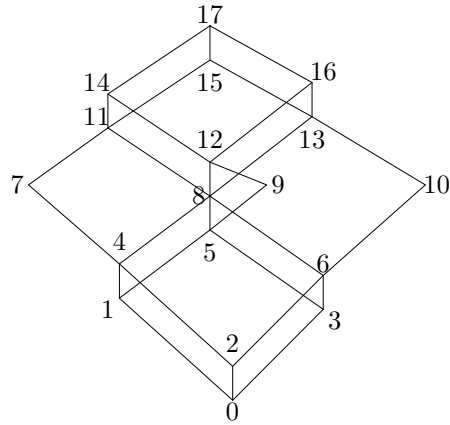

Fig.1

where D_3 is pseudo complemented because

$$\begin{aligned}
 0^* &= 17, \\
 8^* &= 11^* = 12^* = 13^* = 14^* = 15^* = 16^* = 17^* = 0, \\
 1^* &= 10, 6^* = 10^* = 1, \\
 2^* &= 9, 5^* = 9^* = 2, \\
 3^* &= 7, 4^* = 7^* = 3
 \end{aligned}$$

and its correspondent Smarandache lattice is shown in Fig.2.

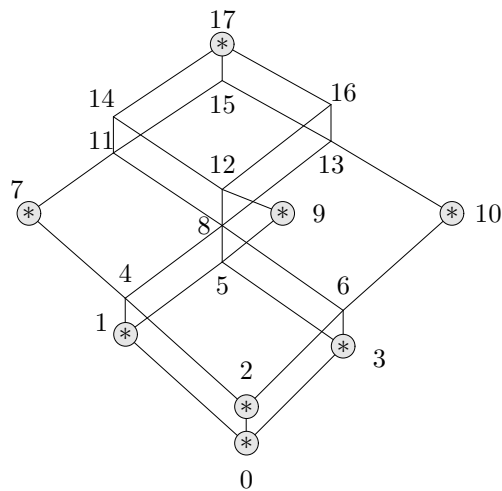

Fig.2

Theorem 3.2 *Let S be a distributive lattice with 0 . If there exist a proper subset NI_P of S , defined Definition 2.4. Then S is a Smarandache lattice.*

Proof By hypothesis, let S be a distributive lattice with 0 and whose proper subset $NI_P = \{I^* \in I_P, I \in I_P\}$ is the set of normal ideals in P . We claim that NI_P is Boolean algebra since $NI_P = \{I^* \in I_P : I \in I_P\}$ is the set of normal ideals in P .

Alternatively, $NI_P = \{I \in I_P : I = I^{**}\}$. Let $I \in I_P$. Take $I^* = \{y \in P : \text{forevery } i \in I : y \wedge i = 0\}$, $I^* \in I_P$. Namely, if $a \in I^*$ then for every $i \in I : a \wedge i = 0$. Let $b \leq a$. Then, obviously, for every $i \in I, b \wedge i = 0$. Thus $b \in I^*$. If $a, b \in I^*$, then for every $i \in I, a \wedge i = 0$, and for every $i \in I, b \wedge i = 0$.

Hence for every $i \in I, (a \wedge i) \vee (b \wedge i) = 0$. By distributive, for every $i \in I, i \wedge (a \vee b) = 0$, i.e., $a \vee b \in I^*$. Thus $I^* \in I_P, I \cap I^* = I \cap \{y \in P, \text{forevery } i \in I, y \wedge i = 0\} = \{0\}$.

Let $I \cap J = \{0\}$ and $j \in J$. Suppose that for some $i \in I, i \wedge j \neq 0$. Then $i \wedge j \in I \cap J$. Because I and J are ideals, so $I \cap J \neq \{0\}$. Hence, for every $i \in I, j \wedge i = 0$, and $j \subseteq I^*$.

Consequently, I^* is a pseudo complement of I and I_P is a pseudo complemented. Therefore I_P is a Boolean algebra. Thus NI_P is the set of all pseudo complements lattice in I_P .

Notice that we have proved that pseudo complemented form a Boolean algebra in Theorem 3.1. Whence, NI_P is a Boolean algebra. By definition, S is a Smarandache lattice. \square

Theorem 3.3 *Let S be a lattice. If there exist a pseudo complemented distributive lattice P , $X^*(P)$ is a sub-lattice of the lattice $I^\delta(P)$ of all δ -ideals of P , which is the proper subset of S . Then S is a Smarandache lattice.*

Proof By hypothesis, let S be a lattice and there exist a pseudo complemented distributive lattice P , $X^*(P)$ is a sub-lattice of the lattice $I^\delta(P)$ of all δ -ideals of P , which is the proper subset of S .

Let $(a^*], (b^*) \in X^*(P)$ for some $a, b \in P$. Clearly, $(a^*] \cap (b^*) \in X^*(P)$. Again, $(a^*] \cup (b^*) = \delta([a]) \cup \delta([b]) = \delta([a] \cup [b]) = \delta([a \cap b]) = ((a \cap b)^*) \in X^*(P)$. Hence $X^*(P)$ is a sub-lattice of $I^\delta(P)$ and it is a distributive lattice. Clearly $(0^{**}]$ and (0^*) are the least and greatest elements of $X^*(P)$.

Now for any $a \in P, (a^*] \cap (a^{**}] = (0]$ and $(a^*] \cup (a^{**}] = \delta([a]) \cup \delta([a^*]) = \delta([a]) \cup ([a^*]) = \delta([a \cap a^*]) = \delta([0]) = \delta(P) = P$. Hence $(a^{**}]$ is the complement of $(a^*]$ in $X^*(P)$.

Therefore $\{X^*(P), \cup, \cap\}$ is a bounded distributive lattice in which every element is complemented.

Thus $X^*(P)$ is also a Boolean algebra, which implies that S is a Smarandache lattice. \square

Theorem 3.4 *Let S be a lattice and P is a pseudo complemented distributive lattice. If S is a Smarandache lattice. Then the following conditions are equivalent:*

- (1) P is a Boolean algebra;
- (2) every element of P is closed;
- (3) every principal ideal is a δ -ideal;
- (4) for any ideal $I, a \in I$ implies $a^{**} \in I$;

- (5) for any proper ideal I , $I \cap D(P) = \phi$;
- (6) for any prime ideal A , $A \cap D(P) = \phi$;
- (7) every prime ideal is a minimal prime ideal;
- (8) every prime ideal is a δ -ideal;
- (9) for any $a, b \in P$, $a^* = b^*$ implies $a = b$;
- (10) $D(P)$ is a singleton set.

Proof Since S is a Smarandache lattice. By definition and previous theorem, we observe that there exists a proper subset P of S such that which is a Boolean algebra. Therefore, P is a Boolean algebra.

(1) \implies (2) Assume that P is a Boolean algebra. Then clearly, P has a unique dense element, precisely the greatest element. Let $a \in P$. Then $a^* \wedge a = 0 = a^* \wedge a^{**}$. Also $a^* \vee a$, $a^* \vee a^{**} \in D(P)$. Hence $a^* \vee a = a^* \vee a^{**}$. By the cancellation property of P , we get $a = a^{**}$. Therefore every element of P is closed.

(2) \implies (3) Let I be a principal ideal of P . Then $I = (a]$ for some $a \in P$. By condition (2), $a = a^{**}$. Now, $(a] = (a^*] = \delta([a^*])$. So $(a]$ is a δ -ideal.

(3) \implies (4) Notice that I be a proper ideal of P . Let $a \in I$. Then there must be $(a] = \delta(F)$ for some filter F of P . Hence, we get that $a^{***} = a^* \in F$. Therefore $a^{**} \in \delta(F) = (a] \subseteq I$.

(4) \implies (5) Let I be a proper ideal of P . Suppose $a \in I \cap D(P)$. Then $a^{**} \in P$ and $a^* = 0$. Therefore $1 = 0^* = a^{**} \in P$, a contradiction.

(5) \implies (6) Let I be a proper ideal of P , $I \cap D(P) = \phi$. Then P is a prime ideal of P , $A \cap D(P) = \phi$.

(6) \implies (7) Let A be a prime ideal of P such that $A \cap D(P) = \phi$ and $a \in A$. Clearly $a \wedge a^* = 0$ and $a \vee a^* \in D(P)$. So $a \vee a^* \notin A$, i.e., $a^* \notin A$. Therefore A is a minimal prime ideal of P .

(7) \implies (8) Let A be a minimal prime ideal of P . It is clear that $P \setminus A$ is a filter of P . Let $a \in A$. Since A is minimal, there exists $b \notin A$ such that $a \wedge b = 0$. Hence $a^* \wedge b = b$ and $a^* \notin A$. Whence, $a^* \in (P \setminus A)$, which yields $a \in \delta(P \setminus A)$. Conversely, let $a \in \delta(P \setminus A)$. Then we get $a^* \notin A$. Thus, we have $a \in A$ and $P = \delta(P \setminus A)$. Therefore A is δ -ideal of P .

(8) \implies (9) Assume that every prime ideal of P is a δ -ideal. Let $a, b \in P$ be chosen that $a^* = b^*$. Suppose $a \neq b$. Then there exists a prime ideal A of P such that $a \in A$ and $b \notin A$. By hypothesis, A is a δ -ideal of P . Hence $A = \delta(F)$ for some filter F of P . Consequently, $a \in A = \delta(F)$, We get $b^* = a^* \in F$. Thus, $b \in \delta(F) = A$, a contradiction. Therefore $a = b$.

(9) \implies (10) Suppose x, y be two elements of $D(P)$. Then $x^* = 0 = y^*$, which implies that $x = y$. Therefore $D(P)$ is a singleton set.

(10) \implies (1) Assume that $D(P) = \{d\}$ is singleton set. Let $a \in P$. We always have $a \vee a^* \in D(P)$. Whence, $a \wedge a^* = 0$ and $a \vee a^* = d$. This true for all $a \in P$. Also $0 \leq a \leq a \vee a^* = d$.

Therefore P is a bounded distributive lattice, in which every element is complemented, Hence the above conditions are equivalent. \square

References

- [1] Florentin Smarandache, *Special Algebraic Structures*, University of New Mexico, 1991, SC: 06A99.
- [2] Gratzer G., *General Lattice Theory*, Academic Press, New York, San Francisco, 1978.
- [3] Monk, J.Donald, Bonnet and Robert eds(1989), *Hand book of Boolean Algebras*, Amsterdam, North Holland Publishing co.
- [4] Padilla, Raul, Smarandache algebraic structure, *International Conference on Semi-Groups*, Universidad do minho, Bra go, Portugal, 18-23 June 1999.
- [5] Padilla, Raul, Smarandache algebraic structure, *Smarandache Notions journal*, Vol.1, 36-38.
- [6] Padilla, Raul, Smarandache algebraic structures, *Bulletin of Pure and Applied Science*, Vol.17.E, NO.1(1998), 119-121.
- [7] Samba Siva Rao, Ideals in pseudo complemented distributive Lattices, *Archivum Mathematicum(Brno)* , No.48(2012), 97-105.
- [8] Sabine Koppel Berg, *General Theory Boolean Algebra*, North Holland, Amsterdam, 1989.
- [9] T.Ramaraj and N.Kannappa, On finite Smarandache near rings, *Scientia Magna*, Vol.1, 2(2005), 49-51.
- [10] N.Kannappa and K.Suresh, On some characterization Smarandache Lattice, *Proceedings of the International Business Management*, Organized by Stella Marie College, Vol.II, 2012, 154-155.

On Soft Mixed Neutrosophic N-Algebraic Structures

F.Smarandache

(University of New Mexico, 705 Gurley Ave., Gallup, New Mexico 87301, USA)

M.Ali

(Department of Mathematics, Quaid-i-Azam University, Islamabad, 44000, Pakistan)

E-mail: fsmarandache@gmail.com, mumtazali770@yahoo.com

Abstract: Soft set theory is a general mathematical tool for dealing with uncertain, fuzzy, not clearly defined objects. In this paper we introduced soft mixed neutrosophic N-algebraic with the discussion of some of their characteristics. We also introduced soft mixed dual neutrosophic N-algebraic structures, soft weak mixed neutrosophic N-algebraic structures, soft Lagrange mixed neutrosophic N-algebraic structures, soft weak Lagrange mixed neutrosophic and soft Lagrange free mixed neutrosophic N-algebraic structures. the so called soft strong neutrosophic loop which is of pure neutrosophic character. We also introduced some of new notions and some basic properties of this newly born soft mixed neutrosophic N-structures related to neutrosophic theory.

Key Words: Neutrosophic mixed N-algebraic structure, soft set, soft neutrosophic mixed neutrosophic N-algebraic structure.

AMS(2010): 53C78

§1. Introduction

Smarandache proposed the concept of neutrosophy in 1980, which is basically a new branch of philosophy that actually deals the origin, nature, and scope of neutralities. He also introduced the neutrosophic logic due to neutrosophy. In neutrosophic logic each proposition is approximated to have the percentage of truth in a subset T , the percentage of indeterminacy in a subset I and the percentage of falsity in a subset F . Basically, a neutrosophic logic is an extension of fuzzy logic. In fact the neutrosophic set is the generalization of classical set, fuzzy conventional set, intuitionistic fuzzy set etc. Neutrosophic logic is used to overcome the problems of imperciseness, indeterminate and inconsistentness of the data. The theory of neutrosophy is also applicable in the field of algebra. For example, Kandasamy and Smarandache introduced neutrosophic fields, neutrosophic rings, neutrosophic vector spaces, neutrosophic groups, neutrosophic bigroups and neutrosophic N-groups, neutrosophic semigroups, neutrosophic bisemi-

¹Received September 5, 2014, Accepted December 12, 2014.

groups, and neutrosophic N-semigroups, neutrosophic loops, neutrosophic biloops, and neutrosophic N-loops, and so on. Mumtaz ali et.al. introduced neutrosophic LA-semigroups and also give their generalization.

Molodtsov introduced the theory of soft set. This mathematical tool is free from parameterization inadequacy, syndrome of fuzzy set theory, rough set theory, probability theory and so on. This theory has been applied successfully in many fields such as smoothness of functions, game theory, operation research, Riemann integration, Perron integration, and probability. Recently soft set theory attained much attention of the researchers since its appearance and the work based on several operations of soft set introduced in [5, 6, 7, 8, 10]. Some properties and algebra may be found in [11]. Feng et.al. introduced soft semirings in [9].

In this paper we introduced soft mixed neutrosophic N-algebraic structures. The organization of this paper is follows. In section one we put the basic concepts about mixed neutrosophic N-algebraic structures and soft sets with some of their operations. In the next sections we introduce soft mixed neutrosophic N-algebraic structures with the construction of some their related theory. At the end we concluded the paper.

§2. Basic Concepts

2.1 Mixed Neutrosophic N-Algebraic Structures

Definition 2.1 Let $\{\langle M \cup I \rangle = (M_1 \cup M_2 \cup \dots \cup M_N, *_{1, *_{2, \dots, *_{N}}})\}$ such that $N \geq 5$. Then $\langle M \cup I \rangle$ is called a mixed neutrosophic N-algebraic structure if

- (1) $\langle M \cup I \rangle = M_1 \cup M_2 \cup \dots \cup M_N$, where each M_i is a proper subset of $\langle M \cup I \rangle$ for all i ;
- (2) some of $(M_i, *_{i})$ are neutrosophic groups;
- (3) some of $(M_j, *_{j})$ are neutrosophic loops;
- (4) some of $(M_k, *_{k})$ are neutrosophic groupoids;
- (5) some of $(M_r, *_{r})$ are neutrosophic semigroups.
- (6) the rest of $(M_t, *_{t})$ can be loops or groups or semigroups or groupoids. ('or' not used in the mutually exclusive sense).

Definition 2.2 Let $\{\langle D \cup I \rangle = (D_1 \cup D_2 \cup \dots \cup D_N, *_{1, *_{2, \dots, *_{N}}})\}$. Then $\langle D \cup I \rangle$ is called a mixed dual neutrosophic N-algebraic structure if

- (1) $\langle D \cup I \rangle = D_1 \cup D_2 \cup \dots \cup D_N$, where each D_i is a proper subset of $\langle D \cup I \rangle$ for all i ;
- (2) some of $(D_i, *_{i})$ are neutrosophic groups;
- (3) some of $(D_j, *_{j})$ are neutrosophic loops;
- (4) some of $(D_k, *_{k})$ are neutrosophic groupoids;
- (5) some of $(D_r, *_{r})$ are neutrosophic semigroups;
- (6) the rest of $(D_t, *_{t})$ can be loops or groups or semigroups or groupoids. ('or' not used in the mutually exclusive sense).

Definition 2.3 Let $\{\langle W \cup I \rangle = (W_1 \cup W_2 \cup \dots \cup W_N, *_{1, *_{2, \dots, *_{N}}})\}$. Then $\langle W \cup I \rangle$ is called a weak mixed neutrosophic N-algebraic structure if

- (1) $\langle W \cup I \rangle = W_1 \cup W_2 \cup \dots \cup W_N$, where each W_i is a proper subset of $\langle W \cup I \rangle$ for all i ;
- (2) some of $(W_i, *i)$ are neutrosophic groups or neutrosophic loops;
- (3) some of $(W_k, *k)$ are neutrosophic groupoids or neutrosophic semigroups;
- (4) the Rest of $(W_t, *t)$ can be loops or groups or semigroups or groupoids. i.e in the collection , all the algebraic neutrosophic structures may not be present.

At most 3-algebraic neutrosophic structures are present and at least 2-algebraic neutrosophic structures are present. Rest being non-neutrosophic algebraic structures.

Definition 2.4 Let $\{\langle V \cup I \rangle = (V_1 \cup V_2 \cup \dots \cup V_N, *1, *2, \dots, *N)\}$. Then $\langle V \cup I \rangle$ is called a weak mixed dual neutrosophic N -algebraic structure if

- (1) $\langle V \cup I \rangle = V_1 \cup V_2 \cup \dots \cup V_N$, where each W_i is a proper subset of $\langle V \cup I \rangle$ for all i ;
- (2) some of $(V_i, *i)$ are neutrosophic groups or neutrosophic loops;
- (3) some of $(V_k, *k)$ are neutrosophic groupoids or neutrosophic semigroups;
- (4) the rest of $(V_t, *t)$ can be loops or groups or semigroups or groupoids.

Definition 2.5 Let $\{\langle M \cup I \rangle = (M_1 \cup M_2 \cup \dots \cup M_N, *1, *2, \dots, *N)\}$ be a neutrosophic N -algebraic structure. A proper subset $\{\langle P \cup I \rangle = (P_1 \cup P_2 \cup \dots \cup P_N, *1, *2, \dots, *N)\}$ is called a mixed neutrosophic sub N -structure if $\langle P \cup I \rangle$ is a mixed neutrosophic N -structure under the operation of $\langle M \cup I \rangle$.

Definition 2.6 Let $\{\langle W \cup I \rangle = (W_1 \cup W_2 \cup \dots \cup W_N, *1, *2, \dots, *N)\}$ be a mixed neutrosophic N -algebraic structure. We call a finite non-empty subset P of $\langle W \cup I \rangle$ to be a weak mixed deficit neutrosophic sub N -algebraic structure if $\{\langle P \cup I \rangle = (P_1 \cup P_2 \cup \dots \cup P_t, *1, *2, \dots, *t)\}$, $1 < t < N$ with $P_i = P \cap L_k$, $1 \leq i \leq t$, and $1 \leq k \leq N$ and some P'_i 's are neutrosophic groups or neutrosophic loops, some P'_j 's are neutrosophic groupoids or neutrosophic semigroups and the rest of P'_k 's are groups or loops or groupoids or semigroups.

Definition 2.7 Let $\{\langle M \cup I \rangle = (M_1 \cup M_2 \cup \dots \cup M_N, *1, *2, \dots, *N)\}$ be a mixed neutrosophic N -algebraic structure of finite order. A proper mixed neutrosophic sub N -structure P of $\langle M \cup I \rangle$ is called Lagrange mixed neutrosophic sub N -structure if $o(P) \mid o \langle M \cup I \rangle$.

If every mixed neutrosophic sub N -structure of $\langle M \cup I \rangle$ is a Lagrange mixed neutrosophic sub N -structures. Then $\langle M \cup I \rangle$ is said to be a Lagrange mixed neutrosophic N -structure.

If some mixed neutrosophic sub N -structure of $\langle M \cup I \rangle$ are Lagrange mixed neutrosophic sub N -structures. Then $\langle M \cup I \rangle$ is said to be a weak Lagrange mixed neutrosophic N -structure.

If every mixed neutrosophic sub N -structure of $\langle M \cup I \rangle$ is not a Lagrange mixed neutrosophic sub N -structures. Then $\langle M \cup I \rangle$ is said to be a Lagrange free mixed neutrosophic N -structure.

2.2 Soft Sets

Throughout this subsection U refers to an initial universe, E is a set of parameters, $P(U)$ is the power set of U , and $A \subset E$. Molodtsov [12] defined the soft set in the following manner.

Definition 2.8 A pair (F, A) is called a soft set over U where F is a mapping given by $F : A \rightarrow P(U)$.

In other words, a soft set over U is a parameterized family of subsets of the universe U . For $e \in A$, $F(a)$ may be considered as the set of a -elements of the soft set (F, A) , or as the set of e-approximate elements of the soft set.

Definition 2.9 For two soft sets (F, A) and (H, B) over U , (F, A) is called a soft subset of (H, B) if

- (1) $A \subseteq B$ and
- (2) $F(a) \subseteq G(a)$, for all $a \in A$.

This relationship is denoted by $(F, A) \widetilde{\subset} (H, B)$. Similarly (F, A) is called a soft superset of (H, B) if (H, B) is a soft subset of (F, A) which is denoted by $(F, A) \widetilde{\supset} (H, B)$.

Definition 2.10 Two soft sets (F, A) and (H, B) over U are called soft equal if (F, A) is a soft subset of (H, B) and (H, B) is a soft subset of (F, A) .

Definition 2.11 (F, A) over U is called an absolute soft set if $F(a) = U$ for all $a \in A$ and we denote it by \mathcal{F}_U .

Definition 2.12 Let (F, A) and (G, B) be two soft sets over a common universe U such that $A \cap B \neq \phi$. Then their restricted intersection is denoted by $(F, A) \cap_R (G, B) = (H, C)$ where (H, C) is defined as $H(c) = F(a) \cap G(a)$ for all $a \in C = A \cap B$.

Definition 2.13 The extended intersection of two soft sets (F, A) and (G, B) over a common universe U is the soft set (H, C) , where $C = A \cup B$, and for all $a \in C$, $H(a)$ is defined as

$$H(a) = \begin{cases} F(a) & \text{if } a \in A - B \\ G(a) & \text{if } a \in B - A \\ F(a) \cap G(a) & \text{if } a \in A \cap B. \end{cases}$$

We write $(F, A) \cap_\varepsilon (G, B) = (H, C)$.

Definition 2.14 The restricted union of two soft sets (F, A) and (G, B) over a common universe U is the soft set (H, C) , where $C = A \cup B$, and for all $a \in C$, $H(a)$ is defined as the soft set $(H, C) = (F, A) \cup_R (G, B)$ where $C = A \cap B$ and $H(a) = F(a) \cup G(a)$ for all $a \in C$.

Definition 2.15 The extended union of two soft sets (F, A) and (G, B) over a common universe U is the soft set (H, C) , where $C = A \cup B$, and for all $a \in C$, $H(a)$ is defined as

$$H(a) = \begin{cases} F(a) & \text{if } a \in A - B \\ G(a) & \text{if } a \in B - A \\ F(a) \cup G(a) & \text{if } a \in A \cap B. \end{cases}$$

We write $(F, A) \cup_\varepsilon (G, B) = (H, C)$.

§3. Soft Mixed Neutrosophic N-Algebraic Structures

Definition 3.1 Let $\langle M \cup I \rangle$ be a mixed neutrosophic N-algebraic structure and let (F, A) be a soft set over $\langle M \cup I \rangle$. Then (F, A) is called a soft mixed neutrosophic N-algebraic structure if and only if $F(a)$ is a mixed neutrosophic sub N-algebraic structure of $\langle M \cup I \rangle$ for all $a \in A$.

Example 3.1 Let $\{\langle M \cup I \rangle = M_1 \cup M_2 \cup M_3 \cup M_4 \cup M_5, *_1, *_2, \dots, *_5\}$ be a mixed neutrosophic 5-structure, where

- $M_1 = \langle \mathbb{Z}_3 \cup I \rangle$, a neutrosophic group under multiplication mod3,
- $M_2 = \langle \mathbb{Z}_6 \cup I \rangle$, a neutrosophic semigroup under multiplication mod6,
- $M_3 = \{0, 1, 2, 3, I, 2I, 3I\}$, a neutrosophic groupoid under multiplication mod4,
- $M_4 = S_3$, and
- $M_5 = \{\mathbb{Z}_{10}$, a semigroup under multiplication mod10}.

Let $A = \{a_1, a_2, a_3\} \subset E$ be a set of parameters and let (F, A) be a soft set over $\langle M \cup I \rangle$, where

$$\begin{aligned} F(a_1) &= \{1, I\} \cup \{0, 3, 3I\} \cup \{0, 2, 2I\} \cup A_3 \cup \{0, 2, 4, 6, 8\}, \\ F(a_2) &= \{2, I\} \cup \{0, 2, 4, 2I, 4I\} \cup \{0, 2, 2I\} \cup A_3 \cup \{0, 5\}, \\ F(a_3) &= \{1, 2\} \cup \{0, 3\} \cup \{0, 2\} \cup A_3 \cup \{0, 2, 4, 6, 8\}. \end{aligned}$$

Clearly (F, A) is a soft mixed neutrosophic 5-algebraic structure over $\langle M \cup I \rangle$.

Proposition 3.1 Let (F, A) and (H, A) be two soft mixed neutrosophic N-algebraic structures over $\langle M \cup I \rangle$. Then their intersection is again a soft mixed neutrosophic N-algebraic structure over $\langle M \cup I \rangle$.

Proof The proof is straightforward. □

Proposition 3.2 Let (F, A) and (H, B) be two soft mixed neutrosophic N-algebraic structures over $\langle M \cup I \rangle$. If $A \cap B = \phi$, then $(F, A) \cap (H, B)$ is a soft mixed neutrosophic N-algebraic structure over $\langle M \cup I \rangle$.

Proof The proof is straightforward. □

Proposition 3.3 Let (F, A) and (H, B) be two soft mixed neutrosophic N-algebraic structure over $\langle M \cup I \rangle$. Then

- (1) their extended intersection is a soft mixed neutrosophic N-algebraic structure over $\langle M \cup I \rangle$;
- (2) their restricted intersection is a soft mixed neutrosophic N-algebraic structure over $\langle M \cup I \rangle$;
- (3) their AND operation is a soft mixed neutrosophic N-algebraic structure over $\langle M \cup I \rangle$.

Remark 3.1 Let (F, A) and (H, B) be two soft mixed neutrosophic N-algebraic structure over

$\langle M \cup I \rangle$. Then

(1) their restricted union may not be a soft mixed neutrosophic N -algebraic structure over $\langle M \cup I \rangle$.

(2) their extended union may not be a soft mixed neutrosophic N -algebraic structure over $\langle M \cup I \rangle$.

(3) their OR operation may not be a soft mixed neutrosophic N -algebraic structure over $\langle M \cup I \rangle$.

To establish the above remark, see the following example.

Example 3.2 Let $\{\langle M \cup I \rangle = M_1 \cup M_2 \cup M_3 \cup M_4 \cup M_5, *_1, *_2, \dots, *_5\}$ be a mixed neutrosophic 5-structure, where

$M_1 = \langle \mathbb{Z}_3 \cup I \rangle$, a neutrosophic group under multiplication mod3,

$M_2 = \langle \mathbb{Z}_6 \cup I \rangle$, a neutrosophic semigroup under multiplication mod6,

$M_3 = \{0, 1, 2, 3, I, 2I, 3I\}$, a neutrosophic groupoid under multiplication mod4,

$M_4 = S_3$, and

$M_5 = \{\mathbb{Z}_{10}$, a semigroup under multiplication mod10}.

Let $A = \{a_1, a_2, a_3\} \subset E$ be a set of parameters and let (F, A) be a soft set over $\langle M \cup I \rangle$, where

$$\begin{aligned} F(a_1) &= \{1, I\} \cup \{0, 3, 3I\} \cup \{0, 2, 2I\} \cup A_3 \cup \{0, 2, 4, 6, 8\}, \\ F(a_2) &= \{2, I\} \cup \{0, 2, 4, 2I, 4I\} \cup \{0, 2, 2I\} \cup A_3 \cup \{0, 5\}, \\ F(a_3) &= \{1, 2\} \cup \{0, 3\} \cup \{0, 2\} \cup A_3 \cup \{0, 2, 4, 6, 8\}. \end{aligned}$$

Let $B = \{a_1, a_4\}$ be a another set of parameters and let (H, B) be a another soft mixed neutrosophic 5-algebraic structure over $\langle M \cup I \rangle$, where

$$\begin{aligned} H(a_1) &= \{1, I\} \cup \{0, 3I\} \cup \{0, 2, 2I\} \cup A_3 \cup \{0, 2, 4, 6, 8\}, \\ H(a_4) &= \{1, 2\} \cup \{0, 3I\} \cup \{0, 2I\} \cup A_3 \cup \{0, 5\}. \end{aligned}$$

Let $C = A \cap B = \{a_1\}$. The restricted union $(F, A) \cup_R (H, B) = (K, C)$, where

$$K(a_1) = F(a_1) \cup H(a_1) = \{1, I, 2\} \cup \{0, 3I\} \cup \{0, 2, 2I\} \cup A_3 \cup \{0, 2, 4, 5, 6, 8\}$$

Thus clearly $\{1, 2, I\}$ and $\{0, 2, 4, 5, 6, 8\}$ in $H(a_1)$ are not subgroups. This shows that (K, C) is not a soft mixed neutrosophic 5-algebraic structure over $\langle M \cup I \rangle$. Similarly one can easily show 2 and 3 by the help of examples.

Definition 3.2 Let $\langle D \cup I \rangle$ be a mixed dual neutrosophic N -algebraic structure and let (F, A) soft set over $\langle D \cup I \rangle$. Then (F, A) is called a soft mixed dual neutrosophic N -algebraic structure if and only if $F(a)$ is a mixed dual neutrosophic sub N -algebraic structure $\langle D \cup I \rangle$ of for all $a \in A$.

Example 3.3 Let $\langle D \cup I \rangle = D_1 \cup D_2 \cup D_3 \cup D_4 \cup D_5, *, *_1, *_2, \dots, *_5$ be a mixed dual neutrosophic 5-algebraic structure, where

$$\begin{aligned} D_1 &= L_7(4), D_2 = S_4, D_3 = \{\mathbb{Z}_{10}, \text{ a semigroup under multiplication modulo } 10\}, \\ D_4 &= \{0, 1, 2, 3, \text{ a groupoid under multiplication modulo } 4\}, \\ D_5 &= \langle L_7(4) \cup I \rangle. \end{aligned}$$

Let $A = \{a_1, a_2\}$ be a set of parameters and let (F, A) be a soft set over $\langle D \cup I \rangle$, where

$$\begin{aligned} F(a_1) &= \{e, 2\} \cup A_4 \cup \{0, 2, 4, 6, 8\} \cup \{0, 2\} \cup \{e, eI, 2, 2I\}, \\ F(a_2) &= \{e, 3\} \cup S_4 \cup \{0, 5\} \cup \{0, 2\} \cup \{e, eI, 3, 3I\} \end{aligned}$$

Clearly (F, A) is a soft mixed dual neutrosophic -structure over $\langle D \cup I \rangle$.

Theorem 3.1 *If $\langle D \cup I \rangle$ is a mixed dual neutrosophic N-algebraic structure. Then (F, A) over $\langle D \cup I \rangle$ is also a soft mixed dual neutrosophic N-algebraic structure.*

Proposition 3.4 *Let (F, A) and (H, B) be two soft mixed dual neutrosophic N-algebraic structures over $\langle D \cup I \rangle$. Then their intersection is again a soft mixed dual neutrosophic N-algebraic structure over $\langle D \cup I \rangle$.*

Proof The proof is straightforward. □

Proposition 3.5 *Let (F, A) and (H, B) be two soft mixed dual neutrosophic N-algebraic structures over $\langle D \cup I \rangle$. If $A \cap B = \phi$, then $(F, A) \cap (H, B)$ is a soft mixed dual neutrosophic N-algebraic structure over $\langle D \cup I \rangle$.*

Proof The proof is straightforward. □

Proposition 3.6 *Let (F, A) and (H, B) be two soft mixed dual neutrosophic N-algebraic structures over $\langle D \cup I \rangle$. Then*

- (1) *their extended intersection is a soft mixed dual neutrosophic N-algebraic structure over $\langle D \cup I \rangle$;*
- (2) *their restricted intersection is a soft mixed dual neutrosophic N-algebraic structure over $\langle D \cup I \rangle$;*
- (3) *their AND operation is a soft mixed dual neutrosophic N-algebraic structure over $\langle D \cup I \rangle$.*

Remark 3.2 Let (F, A) and (H, B) be two soft mixed Dual neutrosophic N-algebraic structures over $\langle D \cup I \rangle$. Then

- (1) *their restricted union may not be a soft mixed dual neutrosophic N-algebraic structure over $\langle D \cup I \rangle$;*
- (2) *their extended union may not be a soft mixed dual neutrosophic N-algebraic structure over $\langle D \cup I \rangle$;*

(3) their *OR* operation may not be a soft mixed dual neutrosophic N -algebraic structure over $\langle D \cup I \rangle$.

One can easily establish the above remarks by the help of examples.

Definition 3.3 Let $\langle W \cup I \rangle$ be a weak mixed neutrosophic N -algebraic structure and let (F, A) soft set over $\langle W \cup I \rangle$. Then (F, A) is called a soft weak mixed neutrosophic N -algebraic structure if and only if $F(a)$ is a weak mixed neutrosophic sub N -structure of $\langle W \cup I \rangle$ for all $a \in A$.

Theorem 3.2 If $\langle W \cup I \rangle$ is a weak mixed neutrosophic N -algebraic structure. Then (F, A) over $\langle W \cup I \rangle$ is also a soft weak mixed neutrosophic N -algebraic structure.

The restricted intersection, extended intersection and the *AND* operation of two soft weak mixed neutrosophic N -algebraic structures is again soft weak mixed neutrosophic N -algebraic structures.

The restricted union, extended union and the *OR* operation of two soft weak mixed neutrosophic N -algebraic structures may not be soft weak mixed neutrosophic N -algebraic structures.

Definition 3.4 Let $\langle V \cup I \rangle$ be a weak mixed dual neutrosophic N -algebraic structure and let (F, A) soft set over $\langle V \cup I \rangle$. Then (F, A) is called a soft weak mixed dual neutrosophic N -algebraic structure if and only if $F(a)$ is a weak mixed dual neutrosophic sub N -structure of $\langle V \cup I \rangle$ for all $a \in A$.

Theorem 3.3 If $\langle V \cup I \rangle$ is a weak mixed dual neutrosophic N -algebraic structure. Then (F, A) over $\langle V \cup I \rangle$ is also a soft weak mixed dual neutrosophic N -algebraic structure.

The restricted intersection, extended intersection and the *AND* operation of two soft weak mixed dual neutrosophic N -algebraic structures is again a soft weak mixed dual neutrosophic N -algebraic structures.

The restricted union, extended union and the *OR* operation of two soft weak mixed dual neutrosophic N -algebraic structures may not be soft weak mixed dual neutrosophic N -algebraic structures.

Definition 3.5 Let (F, A) and (H, B) be two soft mixed neutrosophic N -algebraic structures over $\langle M \cup I \rangle$. Then (H, B) is called soft mixed neutrosophic sub N -algebraic structure of (F, A) , if

- (1) $B \subseteq A$;
- (2) $H(a)$ is a mixed neutrosophic sub N -structure of $F(a)$ for all $a \in A$.

It is important to note that a soft mixed neutrosophic N -algebraic structure can have soft weak mixed neutrosophic sub N -algebraic structure. But a soft weak mixed neutrosophic sub N -structure cannot in general have a soft mixed neutrosophic N -structure.

Definition 3.6 Let $\langle V \cup I \rangle$ be a weak mixed neutrosophic N -algebraic structure and let (F, A) be a soft set over $\langle V \cup I \rangle$. Then (F, A) is called a soft weak mixed deficit neutrosophic N -

algebraic structure if and only if $F(a)$ is a weak mixed deficit neutrosophic sub N -structure of $\langle V \cup I \rangle$ for all $a \in A$.

Proposition 3.7 Let (F, A) and (H, B) be two soft weak mixed deficit neutrosophic N -algebraic structures over $\langle V \cup I \rangle$. Then

- (1) their extended intersection is a soft weak mixed deficit neutrosophic N -algebraic structure over $\langle V \cup I \rangle$;
- (2) their restricted intersection is a soft weak mixed deficit neutrosophic N -algebraic structure over $\langle V \cup I \rangle$;
- (3) their *AND* operation is a soft weak mixed deficit neutrosophic N -algebraic structure over $\langle V \cup I \rangle$.

Remark 3.3 Let (F, A) and (H, B) be two soft weak mixed deficit neutrosophic N -algebraic structures over $\langle V \cup I \rangle$. Then

- (1) their restricted union may not be a soft weak mixed deficit neutrosophic N -algebraic structure over $\langle V \cup I \rangle$;
- (2) their extended union may not be a soft weak mixed deficit neutrosophic N -algebraic structure over $\langle V \cup I \rangle$;
- (3) their *OR* operation may not be a soft weak mixed deficit neutrosophic N -algebraic structure over $\langle V \cup I \rangle$.

One can easily establish the above remarks by the help of examples.

Definition 3.7 Let $\langle M \cup I \rangle$ be a mixed neutrosophic N -algebraic structure and let (F, A) soft set over $\langle M \cup I \rangle$. Then (F, A) is called a soft Lagrange mixed neutrosophic N -algebraic structure if and only if $F(a)$ is a Lagrange mixed neutrosophic sub N -structure of $\langle M \cup I \rangle$ for all $a \in A$.

Theorem 3.4 If $\langle M \cup I \rangle$ is a Lagrange mixed neutrosophic N -algebraic structure. Then (F, A) over $\langle M \cup I \rangle$ is also a soft Lagrange mixed neutrosophic N -algebraic structure.

Remark 3.4 Let (F, A) and (H, B) be two soft Lagrange mixed neutrosophic N -algebraic structures over $\langle M \cup I \rangle$. Then

- (1) their restricted union may not be a soft Lagrange mixed neutrosophic N -algebraic structure over $\langle M \cup I \rangle$;
- (2) their extended union may not be a soft Lagrange mixed neutrosophic N -algebraic structure over $\langle M \cup I \rangle$;
- (3) their *AND* operation may not be a soft Lagrange mixed neutrosophic N -algebraic structure over $\langle M \cup I \rangle$;
- (4) their extended intersection may not be a soft Lagrange mixed neutrosophic N -algebraic structure over $\langle M \cup I \rangle$;
- (5) their restricted intersection may not be a soft Lagrange mixed neutrosophic N -algebraic structure over $\langle M \cup I \rangle$.

(6) their *OR* operation may not be a soft Lagrange mixed neutrosophic N -algebraic structure over $\langle M \cup I \rangle$.

One can easily establish the above remarks by the help of examples.

Now on similar lines, we can define soft Lagrange weak deficit mixed neutrosophic N -algebraic structures.

Definition 3.8 Let $\langle M \cup I \rangle$ be a mixed neutrosophic N -algebraic structure and let (F, A) be a soft set over $\langle M \cup I \rangle$. Then (F, A) is called a soft weak Lagrange mixed neutrosophic N -algebraic structure if and only if $F(a)$ is not a Lagrange mixed neutrosophic sub N -structure of $\langle M \cup I \rangle$ for some $a \in A$.

Remark 3.5 Let (F, A) and (H, B) be two soft weak Lagrange mixed neutrosophic N -algebraic structures over $\langle M \cup I \rangle$. Then

(1) their restricted union may not be a soft weak Lagrange mixed neutrosophic N -algebraic structure over $\langle M \cup I \rangle$;

(2) their extended union may not be a soft weak Lagrange mixed neutrosophic N -algebraic structure over $\langle M \cup I \rangle$;

(3) their *AND* operation may not be a soft weak Lagrange mixed neutrosophic N -algebraic structure over $\langle M \cup I \rangle$;

(4) their extended intersection may not be a soft weak Lagrange mixed neutrosophic N -algebraic structure over $\langle M \cup I \rangle$;

(5) their restricted intersection may not be a soft weak Lagrange mixed neutrosophic N -algebraic structure over $\langle M \cup I \rangle$;

(6) their *OR* operation may not be a soft weak Lagrange mixed neutrosophic N -algebraic structure over $\langle M \cup I \rangle$.

One can easily establish the above remarks by the help of examples. Similarly we can define soft weak Lagrange weak deficit mixed neutrosophic N -algebraic structures.

Definition 3.9 Let $\langle M \cup I \rangle$ be a mixed neutrosophic N -algebraic structure and let (F, A) be a soft set over $\langle M \cup I \rangle$. Then (F, A) is called a soft Lagrange free mixed neutrosophic N -algebraic structure if and only if $F(a)$ is not a Lagrange mixed neutrosophic sub N -structure of $\langle M \cup I \rangle$ for all $a \in A$.

Theorem 3.5 If $\langle M \cup I \rangle$ is a Lagrange free mixed neutrosophic N -algebraic structure. Then (F, A) over $\langle M \cup I \rangle$ is also a soft Lagrange free mixed neutrosophic N -algebraic structure.

Remark 3.6 Let (F, A) and (H, B) be two soft Lagrange free mixed neutrosophic N -algebraic structures over $\langle M \cup I \rangle$. Then

(1) their restricted union may not be a soft Lagrange free mixed neutrosophic N -algebraic structure over $\langle M \cup I \rangle$;

(2) their extended union may not be a soft Lagrange free mixed neutrosophic N -algebraic structure over $\langle M \cup I \rangle$;

(3) their AND operation may not be a soft Lagrange free mixed neutrosophic N -algebraic structure over $\langle M \cup I \rangle$;

(4) their extended intersection may not be a soft Lagrange free mixed neutrosophic N -algebraic structure over $\langle M \cup I \rangle$;

(5) their restricted intersection may not be a soft Lagrange free mixed neutrosophic N -algebraic structure over $\langle M \cup I \rangle$;

(6) their OR operation may not be a soft Lagrange free mixed neutrosophic N -algebraic structure over $\langle M \cup I \rangle$.

One can easily establish the above remarks by the help of examples. Similarly we can define soft Lagrange free weak deficit mixed neutrosophic N -algebraic structures.

§4. Conclusion

This paper is an extension of soft sets to mixed neutrosophic N -algebraic structures. Their related properties and results are explained with illustrative examples.

References

- [1] H.Aktas and N.Cagman, Soft sets and soft group, *Inf. Sci.*, 177(2007), 2726-2735.
- [2] M.Ali, F.Smarandache, M.Shabir and M.Naz, Soft neutrosophic bigroup and soft neutrosophic N -group, *Neutrosophic Sets and Systems*, 2 (2014), 55-81.
- [3] M.I.Ali, F.Feng, X.Y Liu, W.K.Min and M.Shabir, On some new operations in soft set theory, *Comput. Math. Appl.*, (2008), 2621-2628.
- [4] M.Ali, F.Smarandache, and M.Shabir, Soft neutrosophic groupoids and their generalization, *Neutrosophic Sets and Systems*, 6 (2014), 62-81.
- [5] M.Ali, F.Smarandache, M.Shabir and M.Naz, Soft neutrosophic ring and soft neutrosophic field, *Neutrosophic Sets and Systems*, 3 (2014), 55-62.
- [6] M.Ali, C.Dyer, M.Shabir and F.Smarandache, Soft neutrosophic loops and their generalization, *Neutrosophic Sets and Systems*, 4 (2014), 55-75.
- [7] M.Ali, F.Smarandache, M.Naz and M.Shabir, Soft neutrosophic bi-LA-semigroup and soft neutrosophic N -LA-semigroup, *Neutrosophic Sets and Systems*, 5 (2014), 45-58.
- [8] M.Ali, M.Shabir, M.Naz and F.Smarandache, Soft neutrosophic semigroups and their generalization, *Scientia Magna*, Vol.10, 1(2014), 93-111.
- [9] M.Aslam, M.Shabir, A.Mehmood, Some studies in soft LA-semigroup, *Journal of Advance Research in Pure Mathematics*, 3 (2011), 128 – 150.
- [10] K.Atanassov, Intuitionistic fuzzy sets, *Fuzzy Sets Syst.*, Vol.64, 2(1986), 87-96.
- [11] W.B.V.Kandasamy and F.Smarandache, *Some Neutrosophic Algebraic Structures and Neutrosophic N -Algebraic Structures*, Hexis, 2006.
- [12] W.B.V.Kandasamy and F.Smarandache, *N -Algebraic Structures and S - N -Algebraic Structures*, Hexis, Phoenix, 2006.

- [13] W.B.V.Kandasamy and F.Smarandache, *Basic Neutrosophic Algebraic Structures and their Applications to Fuzzy and Neutrosophic Models*, Hexis, 2004.
- [14] P.K.Maji, Neutrosophic soft set, *Annals of Fuzzy Mathematics and Informatics*, Vol.5, 1(2013), 2093-9310.
- [15] P.K.Maji, R.Biswas and R.Roy, Soft set theory, *Comput. Math. Appl.*, 45(2003), 555-562.
- [16] P.K.Maji, A.R.Roy and R.Biswas, An application of soft sets in a decision making problem, *Comput. Math. Appl.*, 44(2002), 1007-1083.
- [17] D.Molodtsov, Soft set theory first results, *Comput. Math. Appl.*, 37(1999), 19-31.
- [18] Z.Pawlak, Rough sets, *Int. J. Inf. Compu. Sci.*, 11(1982), 341-356.
- [19] M.Shabir, M.Ali, M.Naz and F.Smarandache, Soft neutrosophic group, *Neutrosophic Sets and Systems*, 1 (2013), 5-12.
- [20] F.Smarandache, *A Unifying Field in Logics. Neutrosophy, Neutrosophic Probability, Set and Logic*, Rehoboth, American Research Press, (1999).
- [21] L.A.Zadeh, Fuzzy sets, *Inform. Control*, 8(1965), 338 -353.

Papers Published in IJMC, 2014

Vol.1,2014

1. Some Results in Fuzzy and Anti Fuzzy Group Theory B.O.Onasanya and S.A.Ikort	01
2. Contributions to Differential Geometry of Partially Null Curves in Semi-Euclidean Space E_1^4 Süha Yılmaz, Emin özyılmaz and Ümit Ziya Savcı	06
3. Existence Results of Unique Fixed Point in 2-Banach Spaces G.S.Saluja	13
4. Total Domination in Lict Graph Girishi.V.R. and P.Usha	19
5. The Genus of the Folded Hypercube R.X.Hao, W.M.Cairen, H.Y.Liu	28
6. Characteristic Polynomial & Domination Energy of Some Special Class of Graphs M.Kamal Kumar	37
7. On Variation of Edge Bimagic Total Labeling A.Amara Jothi, N.G.David and J.Baskar Babujee	49
8. Characterization of Pathos Adjacency Blict Graph of a Tree Nagesh H.M. and R.Chandrasekhar	61
9. Regularization and Energy Estimation of Pentahedra (Pyramids) Using Geometric Element Transformation Method Buddhadev Pal and Arindam Bhattacharyya	67
10. Algorithmic and NP-Completeness Aspects of a Total Lict Domination Number of a Graph Girish V.R. and P.Usha	80
11. Upper Singed Domination Number of Graphs H.B.Walikal et al	87
12. Star Chromatic and Defining Number of Graphs D.A.Mojdeh et al	93
13. Bounds for the Harmonious Coloring of Myceilskians Vernold V.J.	102
14. A Topological Model for Ecologically Industrial Systems Linfan Mao	109

Vol.2,2014

1. On Ruled Surfaces in Minkowski 3-Space Yılmaz Tunçer, Nejat Ekmekci, Semra Kaya Nurkan	01
2. Enumeration of k-Fibonacci Paths Using Infinite Weighted Automata Rodrigo de Castro and José L.Ramírez	20
3. One Modulo N Gracefullness Of Arbitrary Supersubdivisions of Graphs V.Ramachandran and C.Sekar	36
4. The Natural Lift Curves and Geodesic Curvatures of the Spherical Indicatrices of The Spacelike-Timelike Bertrand Curve Pair	

Süleyman Şenyurt and Ömer Faruk Çalışkan.....	47
5. Anisotropic Cosmological Models of Finsler Space with (γ, β) -Metric	
Arunesh Pandey, V.K.Chaubey and T.N.Pandey	63
6. Characterizations of Space Curves According to Bishop Darboux	
Vector in Euclidean 3-Space E^3	
Süleyman Şenyurt, Ömer Faruk Çalışkan, Hatice Kübra ÖZ.....	74
7. Magic Properties of Special Class of Trees	
M.Murugan.....	81
8. On Pathos Adjacency Cut Vertex Jump Graph of a Tree	
Nagesh H.M and R.Chandrasekhar	89
9. Just nr -Excellent Graphs	
S.Suganthi, V.Swaminathan, A.P.Pushpalatha and G.Jothilakshmi	96
10. Total Dominator Colorings in Caterpillars	
A.Vijayalekshmi	116

Vol.3,2014

1. Mathematics on Non-Mathematics – A Combinatorial Contribution	
Linfan Mao.....	01
2. On Cosets and Normal Subgroups	
B.O.Onasanya and S.A.Ikort	35
3. On Radio Mean Number of Some Graphs	
By R.Ponraj and S.Sathish Narayanan	41
4. Semientire Equitable Dominating Graphs	
B.Basavanagoud, V.R.Kulli andD Vijay V.Teli	49
5. Friendly Index Sets and Friendly Index Numbers of Some Graphs	
Pradeep G.Bhat and Devadas Nayak C.....	55
6. Necessary Condition for Cubic Planar 3-Connected Graph to be	
Non-Hamiltonian with Proof of Barnette's Conjecture	
Mushtaq Ahmad Shah	70
7. Odd Sequential Labeling of Some New Families of Graphs	
Lekha Bijukumar	89
8. Mean Labelings on Product Graphs	
Teena Liza John and Mathew Varkey T.K.....	97
9. Total Near Equitable Domination in Graphs	
Ali Mohammed Sahal and Veena Mathad	104

Vol.4,2014

1. Spacelike Curves of Constant Breadth According to Bishop Frame in \mathbb{E}_1^3	
Süha Yılmaz, Ümit Ziya Savcıand Yasin Ünlütürk.....	01
2. Study Map of Orthotomic of a Circle	
Ö. Gökmen Yıldız and H.Hilmi Hacisalihoglu	07

3. Geometry on Non-Solvable Equations - A Review on Contradictory Systems Linfan Mao	18
4. On Generalized Quasi-Kenmotsu Manifolds Barnali Laha and Arindam Bhattacharyya	39
5. On Super (a, d)-Edge-Antimagic Total Labeling of a Class of Trees A.Raheem, A.Q.Baig and M.Javaid	47
6. Total Mean Cordial Labeling of Graphs R.Ponraj, S.Sathish Narayanan and A.M.S.Ramasamy	56
7. Smarandache's Conjecture on Consecutive Primes Octavian Cira	69
8. The Neighborhood Pseudochromatic Number of a Graph B.Sooryanarayana and Narahari N.	92
9. Signed Domatic Number of Directed Circulant Graphs Gunasekaran and A.Devika	100
10. Neighborhood Total 2-Domination in Graphs C.Sivagnanam	108
11. Smarandache Lattice and Pseudo Complement N.Kannappa and K.Suresh	120
12. Soft Mixed Neutrosophic N-Algebraic Structures F.Smarandache and M.Ali	127

Any mathematical science can be reconstructed from or made by combinatorialization.

By Linfan MAO, A Chinese mathematician.

Author Information

Submission: Papers only in electronic form are considered for possible publication. Papers prepared in formats, viz., .tex, .dvi, .pdf, or.ps may be submitted electronically to one member of the Editorial Board for consideration in the **International Journal of Mathematical Combinatorics** (*ISSN 1937-1055*). An effort is made to publish a paper duly recommended by a referee within a period of 3 months. Articles received are immediately put the referees/members of the Editorial Board for their opinion who generally pass on the same in six week's time or less. In case of clear recommendation for publication, the paper is accommodated in an issue to appear next. Each submitted paper is not returned, hence we advise the authors to keep a copy of their submitted papers for further processing.

Abstract: Authors are requested to provide an abstract of not more than 250 words, latest Mathematics Subject Classification of the American Mathematical Society, Keywords and phrases. Statements of Lemmas, Propositions and Theorems should be set in italics and references should be arranged in alphabetical order by the surname of the first author in the following style:

Books

[4]Linfan Mao, *Combinatorial Geometry with Applications to Field Theory*, InfoQuest Press, 2009.

[12]W.S.Massey, *Algebraic topology: an introduction*, Springer-Verlag, New York 1977.

Research papers

[6]Linfan Mao, Mathematics on non-mathematics - A combinatorial contribution, *International J.Math. Combin.*, Vol.3(2014), 1-34.

[9]Kavita Srivastava, On singular H-closed extensions, *Proc. Amer. Math. Soc.* (to appear).

Figures: Figures should be drawn by TEXCAD in text directly, or as EPS file. In addition, all figures and tables should be numbered and the appropriate space reserved in the text, with the insertion point clearly indicated.

Copyright: It is assumed that the submitted manuscript has not been published and will not be simultaneously submitted or published elsewhere. By submitting a manuscript, the authors agree that the copyright for their articles is transferred to the publisher, if and when, the paper is accepted for publication. The publisher cannot take the responsibility of any loss of manuscript. Therefore, authors are requested to maintain a copy at their end.

Proofs: One set of galley proofs of a paper will be sent to the author submitting the paper, unless requested otherwise, without the original manuscript, for corrections after the paper is accepted for publication on the basis of the recommendation of referees. Corrections should be restricted to typesetting errors. Authors are advised to check their proofs very carefully before return.



Contents

Spacelike Curves of Constant Breadth According to Bishop Frame in E_1^3
By Süha Yılmaz, Ümit Ziya Savcı and Yasin Ünlütürk 01

Study Map of Orthotomic of a Circle
By Ö. Gökmen Yıldız and H.Hilmi Hacisalihoğlu 07

Geometry on Non-Solvable Equations-A Review on Contradictory Systems
By Linfan Mao 18

On Generalized Quasi-Kenmotsu Manifolds
By Barnali Laha and Arindam Bhattacharyya 39

On Super (a, d)-Edge-Antimagic Total Labeling of a Class of Trees
By A.Raheem, A.Q.Baig and M.Javaid 47

Total Mean Cordial Labeling of Graphs
By R.Ponraj, S.Sathish Narayanan and A.M.S.Ramasamy 56

Smarandache’s Conjecture on Consecutive Primes By Octavian Cira 69

The Neighborhood Pseudochromatic Number of a Graph
By B.Sooranarayana and Narahari N. 92

Signed Domatic Number of Directed Circulant Graphs
By Gunasekaran and A.Devika 100

Neighborhood Total 2-Domination in Graphs By C.Sivagnanam 108

Smarandache Lattice and Pseudo Complement
By N.Kannappa and K.Suresh 120

Soft Mixed Neutrosophic N-Algebraic Structures
By F.Smarandache and M.Ali 127

Papers Published in IJMC, 2014 139

